

Technology & Tai-wa
for Tomorrow



Investor Day 2024

SECTION 1
June 18, 2024

Forward-looking statements

This presentation has been prepared solely for the purpose of presenting relevant information regarding KOKUSAI ELECTRIC CORPORATION (“KE”).

This presentation is based on the economic, regulatory, market and other conditions as in effect on the date hereof, and neither KE nor its advisors or representatives guarantee that the information contained in this presentation is accurate or complete. Subsequent developments may affect the information contained in this presentation, and neither KE nor its advisors or representatives are under any obligation to update, revise or affirm the information herein based on events or circumstances after the date hereof. The information in this presentation is subject to change without prior notice.

Neither this presentation nor any of its contents may be disclosed to or used by any other party for any purpose without the prior written consent of KE.

This presentation contains statements that constitute forward-looking statements, including estimations, forecasts, targets and plans. Such forward-looking statements do not represent any guarantee by management of future performance. Any forward-looking statements in this document are based on the current assumptions and beliefs of KE in light of the information currently available to it and involve known and unknown risks, uncertainties and other factors. Such risks, uncertainties and other factors may cause KE actual results, performance, achievements or financial position to be materially different from any future results, performance, achievements or financial position expressed or implied by such forward-looking information. KE assumes no obligation and does not intend to update or revise any forward-looking statements to reflect future developments or circumstances.

Unless context requires otherwise, the financial figures used in this presentation are on a consolidated basis. KE’s current fiscal year end is March 31. This presentation includes financial information that has not been audited by our independent registered public accounting firm, and, as a result, those figures are subject to change. This presentation contains certain financial measures presented on a basis not in accordance with International Financial Reporting Standards (“IFRS”), including adjusted operating profit, adjusted EBITDA, adjusted net income, adjusted FCF, normalized adjusted operating profit, normalized adjusted EBITDA, normalized adjusted net income and normalized adjusted FCF. These non-IFRS financial measures should not be considered in isolation or as a substitute for the most directly comparable financial measures presented in accordance with IFRS.

Today's Agenda

Part 1

9:00 ○ Industry Update from Applied Materials – Mr. Terrance Lee, Corporate VP, Applied Materials

9:20 ○ Overview of Kokusai Electric – Fumiya Kanai, Representative Director, President and CEO

9:30 ○ Q&A

9:50 ○ Break

Part 2

10:00 ○ Management Strategies (Market and Growth Outlook) – Kazunori Tsukada, Executive VP

10:10 ○ Equipment (NAND · DRAM) – Shigeru Odake, Corporate VP

10:20 ○ Equipment (Logic · Mature Logic · Treatment) – Kenji Kanayama, Senior VP

10:30 ○ Service – Naotoshi Yamamine, Senior VP

10:40 ○ Global Operation – Masayuki Yamada, Senior VP

10:50 ○ Financial – Yoshitaka Kawakami, Senior VP

11:00 ○ Q&A

Special Guest from Applied Materials



TERRANCE LEE

Corporate Vice President, GM
Etch Products Business Unit
Semiconductor Products Group



- Terrance Lee is a corporate vice president for the Etch Products Business Unit. He is responsible for defining the strategic roadmap and marketing of Etch products.
- Previously, he worked in DCVD, Chemical Mechanical Planarization and Plating Business Units. Before joining Applied Materials, he held executive positions in Business Development and Finance in the capital equipment sector.
- Mr. Lee earned a Bachelor of Science degree in Chemical Engineering from UC Berkeley and holds patents in CVD, CMP and Etch.

KOKUSAI ELECTRIC's Experienced Management Team

Strong Leadership by Semiconductor Industry Specialists × Disciplined Governance

Executive Officers



Fumiyuki Kanai
Representative Director
President and CEO



Hidehiro Yanagawa
Executive VP
Head of Business Development, Sales, DX/IT, Information Security



Kazunori Tsukada
Executive VP
Head of Corporate Planning, Export Control, Legal, Intellectual Property, PR & IR, Sustainability

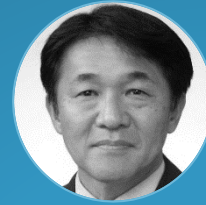

Masayuki Yamada
Senior VP
Head of Global Supply Chain, Quality Assurance, Site Operations



Yoshitaka Kawakami
Senior VP
Finance & Accounting



Kenji Kanayama
Senior VP
Technology Management, Process Technology Development



Naotoshi Yamamine
Senior VP
Services, Field Engineering, Group Governance



Masami Miyamoto
Corporate VP
Sales

Years of Experience in Industry :

43yrs

36yrs

38yrs

41yrs

35yrs

33yrs

34yrs

34yrs

Executive Officers

Business Strategy

Accounting

Directors

Independent Directors



Shigeru Odake
Corporate VP
System Technology Development, Technical Support Center



Teruhiko Kawakami
Corporate VP
HR & Corporate Administration, Ethics & Compliance



Takashi Hashimoto
VP
Business Strategy



Hajime Oyama
VP
Accounting



Yuji Kamiya
Director



Unryu Ogawa
Director
Executive Fellow



Masaaki Tsuruta
ex-CEO of Samsung Japan;
ex-Deputy of Sony's Semi Business



Noriko Sakai
Partner, HIRAKAWA International Law Office;
ex-Partner at O'Melveny, TMI Associates

Years of Experience in Industry :

32yrs

32yrs

41yrs

29yrs

43yrs

27yrs

Values :

Knowledge and Experience in Semiconductor Industry

Disciplined Governance, International Legal Expertise

SAMSUNG/SONY

O'Melveny / TMI ASSOCIATES

KOKUSAI ELECTRIC at a Glance

70+ Year History with a Specialty Position in the Batch Deposition Market, with High-Quality Products / Services Valued by Customers

Company Overview

History



Key Financials

FY24/3 Financial Highlight

Revenue	JPY 180.8Bil
Adjusted Earnings per Share	JPY 118.12
GP Margin	41.5%
Adjusted Operating Margin	20.9%

Market Share

Batch ALD⁽¹⁾ No.1
 Worldwide Market Share in 2023⁽²⁾

Treatment No.3
 Worldwide Market Share in 2023⁽³⁾

Manufacturing Sites



of Employees (As of 24/3, Consolidated)



FY24/3 Revenue Breakdown by Business

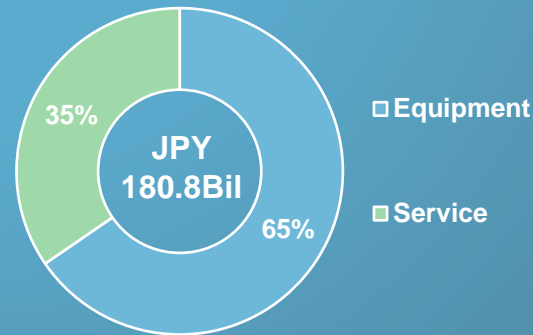

FY24/3 Equipment Revenue Breakdown by Application

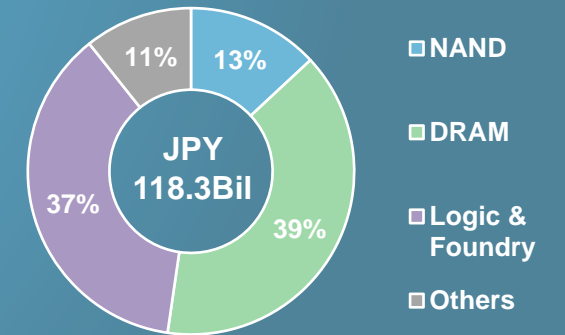

Recent Awards



Notes:

1. We refer to a technique for thin-film deposition at an atomic layer level involving a process of cyclical supply of multiple gases as "ALD"
2. Source: TechInsights Inc. (VLSI) "TL ALD Tools_YEARLY" 2024 (April)
3. Gartner® Market Share: Semiconductor Wafer Fab Equipment, Worldwide, 2023, Bob Johnson, Gaurav Gupta, Menglin Cao, 1, May 2024
Gartner research. Calculations performed by KE. Treatment: RTP and Oxidation/Diffusion
 GARTNER is a registered trademark and service mark of Gartner, Inc. and/or its affiliates in the U.S. and internationally and is used herein with permission. All rights reserved. Gartner does not endorse any vendor, product or service depicted in its research publications, and does not advise technology users to select only those vendors with the highest ratings or other designation. Gartner research publications consist of the opinions of Gartner's research organization and should not be construed as statements of fact. Gartner disclaims all warranties, expressed or implied, with respect to this research, including any warranties of merchantability or fitness for a particular purpose.

Management Policy

Driving Economic, Environmental, and Social Value through “KOKUSAI ELECTRIC Way”

KOKUSAI ELECTRIC Way

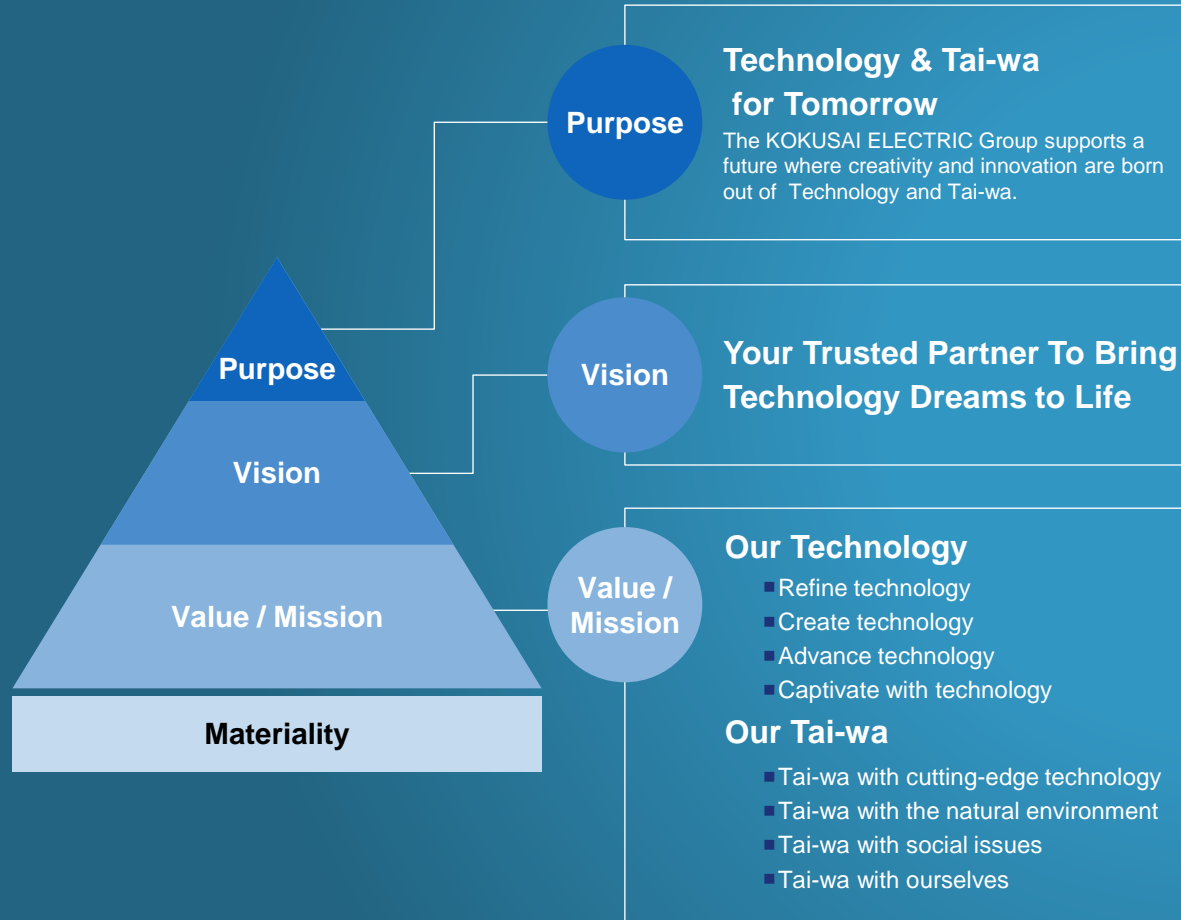

Sustainability Management

Contribute to the realization of a sustainable society and the achievement of SDGs



Expanding corporate value and sustainable development

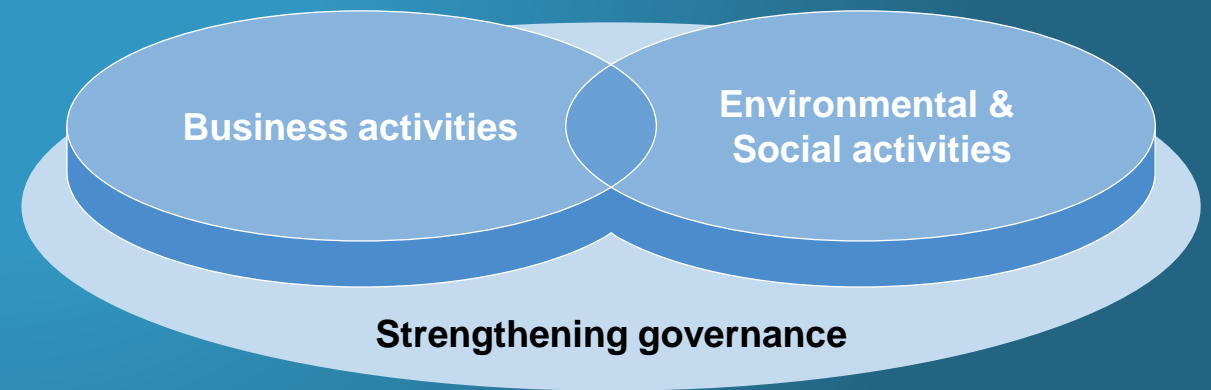

Our Business and Major Products

Specializing in Film Deposition, with Batch ALD and Treatment Equipment as Our Main Products, Leading in Global Market Share

Business Profile and Revenue Breakdown (FY24/3)

Equipment (65%)

Batch Deposition

Batch ALD

Worldwide Market Share No.1 (CY2023)⁽¹⁾

- Batch deposition equipment that can process over dozens of wafers at once and is compatible with Atomic Layer Deposition (ALD) technology.
- ALD applies thin-film deposition at an atomic layer level, involving a process of cyclical supply of multiple gases as "ALD".

Batch CVD

- Chemical Vapor Deposition (CVD) involves multiple gases flowing simultaneously into a chamber, reacting in the gas phase.
- Main focus on Low Pressure CVD.

Treatment

Worldwide Market Share No.3 (CY2023)⁽²⁾

- Treatment equipment improves film properties by applying plasma and heat on thin film to remove impurities from film and stabilize particles.
- As semiconductor devices became more complex, Treatment demand has grown in low temperature as well as with excellent isotropy and step coverage.

Service (35%)

- After-sales service for semiconductor manufacturing equipment:

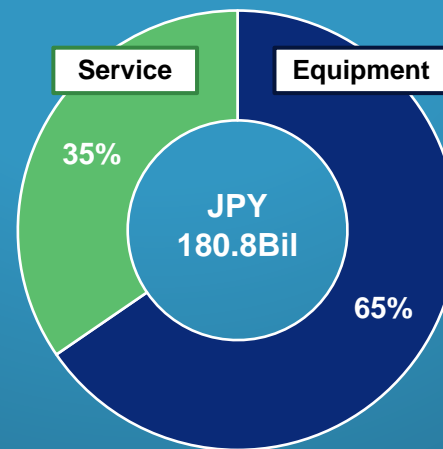

Notes:

1. Source: TechInsights Inc.(VLSI) "TI_ALD Tools_YEARLY" 2024 (April)

2. Gartner®, Market Share: Semiconductor Wafer Fab Equipment, Worldwide, 2023, Bob Johnson, Gaurav Gupta, Menglin Cao, 1, May 2024

Gartner research. Calculations performed by KE. Treatment: RTP and Oxidation/Diffusion

GARTNER is a registered trademark and service mark of Gartner, Inc. and/or its affiliates in the U.S. and internationally and is used herein with permission. All rights reserved. Gartner does not endorse any vendor, product or service depicted in its research publications, and does not advise technology users to select only those vendors with the highest ratings or other designation. Gartner research publications consist of the opinions of Gartner's research organization and should not be construed as statements of fact. Gartner disclaims all warranties, expressed or implied, with respect to this research, including any warranties of merchantability or fitness for a particular purpose.

Major Products

Large batch deposition "AdvancedAce®-300"

- Compatible with technology including batch ALD, batch CVD, oxidation, diffusion and steady annealing.



Mini batch deposition "TSURUGI-C²® 劔®"

- Capable of both highly difficult deposition and high productivity on next-generation devices.
- Compatible with thin film formation processes, incl. latest batch ALD technology.



Single-wafer treatment "MARORA®"

- Applies plasma and heat on film.
- Able to treat complex semiconductor shapes with high productivity and quality.



Single-wafer treatment "TANDUO®"

- Applies heat on thin film.
- Capable of annealing in low temperature.



High-Temp Activation Anneal (New Product)

- Adopts a new heating system for ultra high temperature and 150/200mm common platform.
- Mass production is expected to begin in 2025.



Our Technological Strength

As Semiconductor Manufacturing Processes Evolve, Our Technological Strengths are Becoming Increasingly Important

Batch ALD Technology

- ✓ The complexity of semiconductor devices boosts the need for batch ALD with high productivity and quality
- ✓ Implementation in NAND is already advanced, and future demand increase is expected in DRAM and Logic/Foundry

Increased demand for batch ALD that can achieve both high productivity and highly difficult film deposition

Batch Deposition
High Productivity



ALD Technology
High Quality

Process dozens or more wafers simultaneously

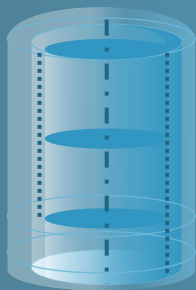

Gas reacts on the surface

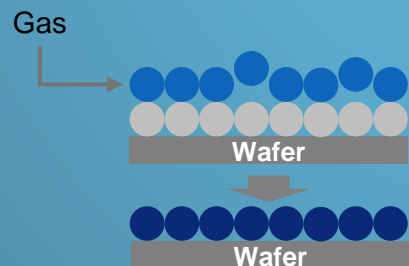

for illustrative purposes

Treatment Technology

- ✓ As the deposition process advances towards lower temperatures, the need for plasma-assisted treatment is increasing
- ✓ Our unique plasma method creates abundant radicals, achieving excellent isotropy and step coverage, enhancing film quality with high productivity

1 After Deposition in Low Temperature Environment

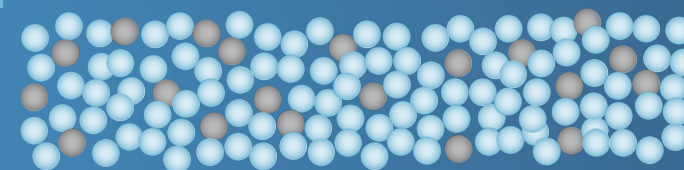

2 Remove Impurities with plasma & heat

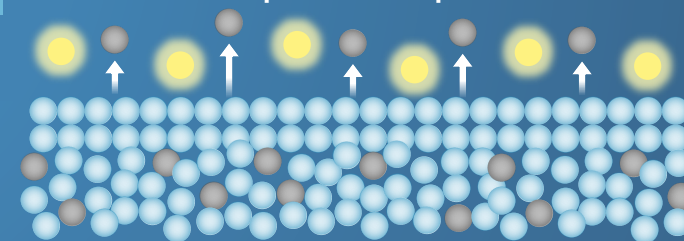

3 After Treatment (Film Property Improvement)

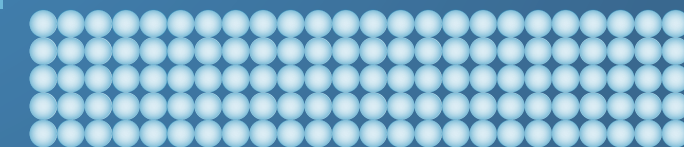

Mid-term Management Strategies

Mid-term Management Strategies to Achieving Growth Higher than WFE

1

Expand Sales of Batch ALD and Treatment Equipment that Process the Increasing Complexity and 3D Devices of Various Applications

2

Expand Sales of Batch Equipment for Mature Nodes and Equipment for SiC Power Devices

3

Expand the High-Profit Service Business that Meets Customer Needs throughout the Entire Product Lifecycle



Our Key Growth Drivers

Clear Growth Drivers across Device Types, Contributing to Higher and More Stable Growth and Profitability

NAND

- Market recovery from CY2025
- Even higher market shares as the device moves to >200 layers

DRAM

- Increasing market shares in D1b and D1c, with strong tailwind of HBM
- Structural shift to vertical DRAM and 3D-Stacked DRAM

Logic / Foundry

- Increasing market shares in GAA (N2 and N1.4)
- New application in Si Interposer
- Mature nodes in US / Europe

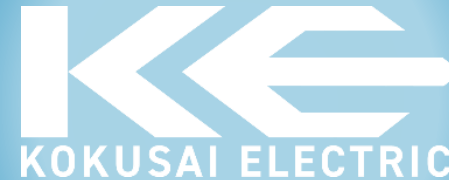

Treatment

- NAND market recovery
- New PORs⁽¹⁾ in DRAM, with HBM tailwind
- Aiming to expand to Logic

SiC Power Device

- Already expanding sales in conventional processes
- New high-temp anneal equipment in CY2025
- New solution of ALD-SiO

Service

- Increase of installed base and service sales per unit
- Expansion of global service network to address localization

Note:

1. POR: An abbreviation for Process of Record, which refers to the qualification of manufacturing equipment in a customer's semiconductor manufacturing process.

Mid-Term Objectives⁽¹⁾ - Summary

We Updated Mid-Term Objectives with Higher Margins and More Balanced Application Mix

	FY2023/3	FY2024/3	Mid-Term Objectives
WFE Assumption	\$100 Bil (CY2022) ⁽²⁾	\$100 Bil (CY2023) ⁽²⁾	> \$120 Bil
Revenue	JPY 246 Bil	JPY 181 Bil	> JPY 330 Bil
Equipment (% Revenue)	69%	65%	~ 75%
Service (% Revenue)	31%	35%	> 25%
Adjusted OP Margin⁽³⁾	26.1%	20.9%	> 30%
R&D (% Revenue)	5.1%	7.0%	> 6%

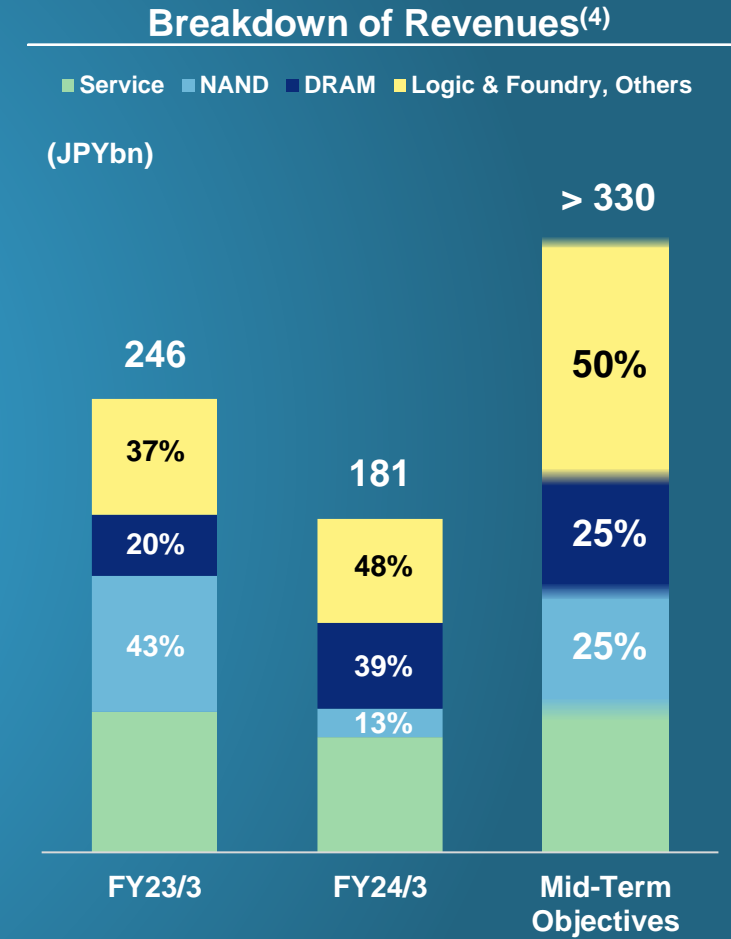

Notes:

1. Regarding the Mid-Term Objectives, the landing prospects for the Mid-to-Long Term Objectives at the current point in time are described based on the current environment and progress

2. KE estimates

3. Adjusted Operating Profit is calculated as operating profit – other income + other expenses + purchase price allocation amortization + stand-alone related expenses + stock-based compensation (except for performance-linked stock compensation). Adjusted Operating Profit Margin is calculated as Adjusted Operating Profit / Revenue

4. Percentage of equipment revenue

5. The forward-looking statements included above are based on the current assumptions and beliefs of KE in light of the information currently available to it and involve known and unknown risks, uncertainties and other factors. Such risks, uncertainties and other factors may cause KE's actual results, performance, achievements or financial position to be materially different from any future results, performance, achievements or financial position expressed or implied by such forward-looking information

Technology & Tai-wa
for Tomorrow



Investor Day 2024

SECTION 2
June 18, 2024



Market and Growth Outlook

Kazunori Tsukada, Executive VP

Head of Corporate Planning, Export Control, Legal, Intellectual Property, PR & IR, Sustainability

Trends and Outlook of Semiconductor Device

Semiconductor Market Recovering from CY2024, and Megatrends Driving the Semiconductor Market Towards \$1Tn

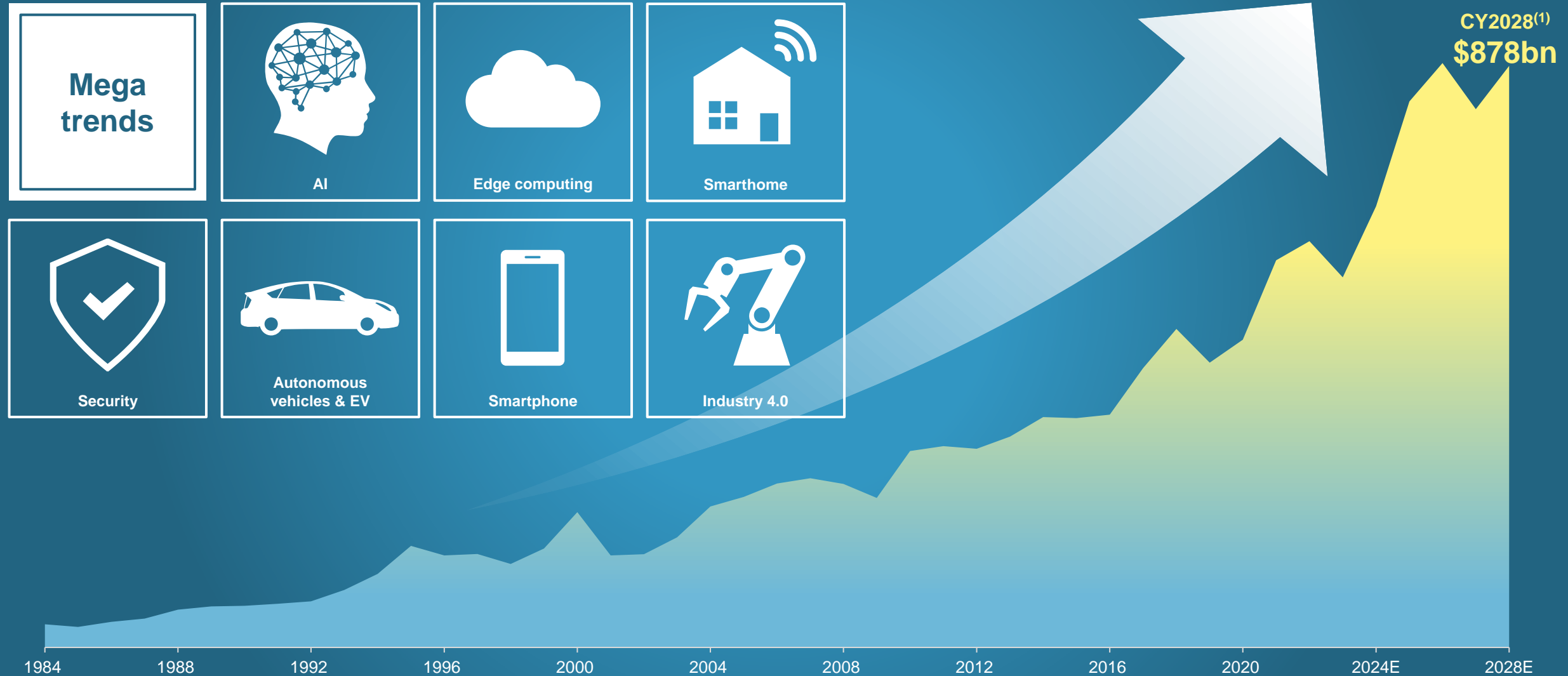

Trends and Outlook of WFE Markets by Application

DRAM and Logic/Foundry Expected to Exceed Previous Peak Levels, and NAND Expected to Recover to a Peak Level of 2021

WFE (Wafer Fab Equipment) Market by Application⁽¹⁾

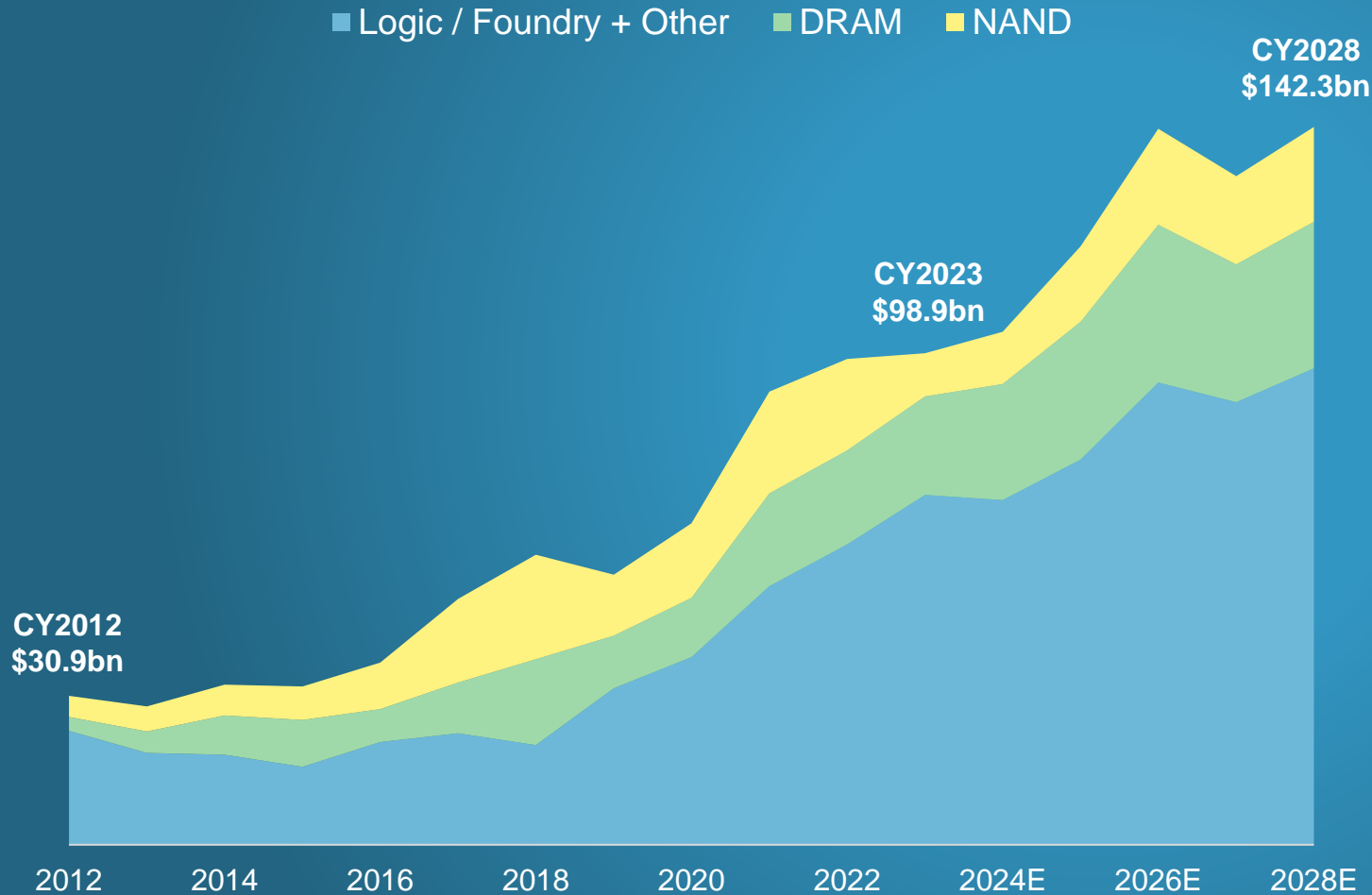

WFE Market Growth⁽¹⁾

(\$bn)	2021	2023	2028E
Memory	35.4	25.8	44.0
NAND	18.5	7.9	17.3
DRAM	16.8	17.9	26.7
Logic / Foundry + Other	47.1	63.7	86.8
Total	90.8	98.9	142.3

Specialty Position in Batch Deposition / Treatment Market

Aim to Increase Market Share in Batch ALD / Plasma Modification, Fast Growing Markets due to Higher Device Complexity

Worldwide Compelling Position in Batch / Treatment Equipment Market

(CY2023A) Market Share Based on Gartner's Categories⁽¹⁾

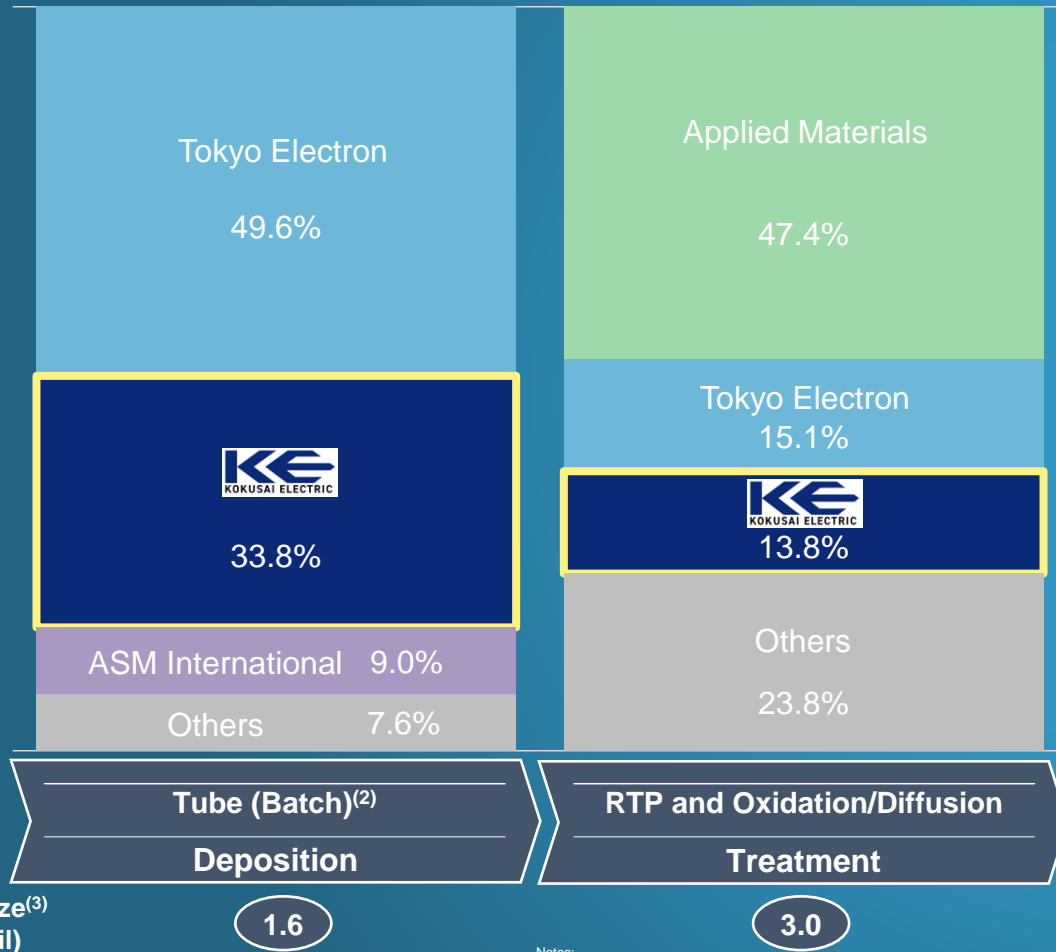

Breakdown of Batch and Treatment Market

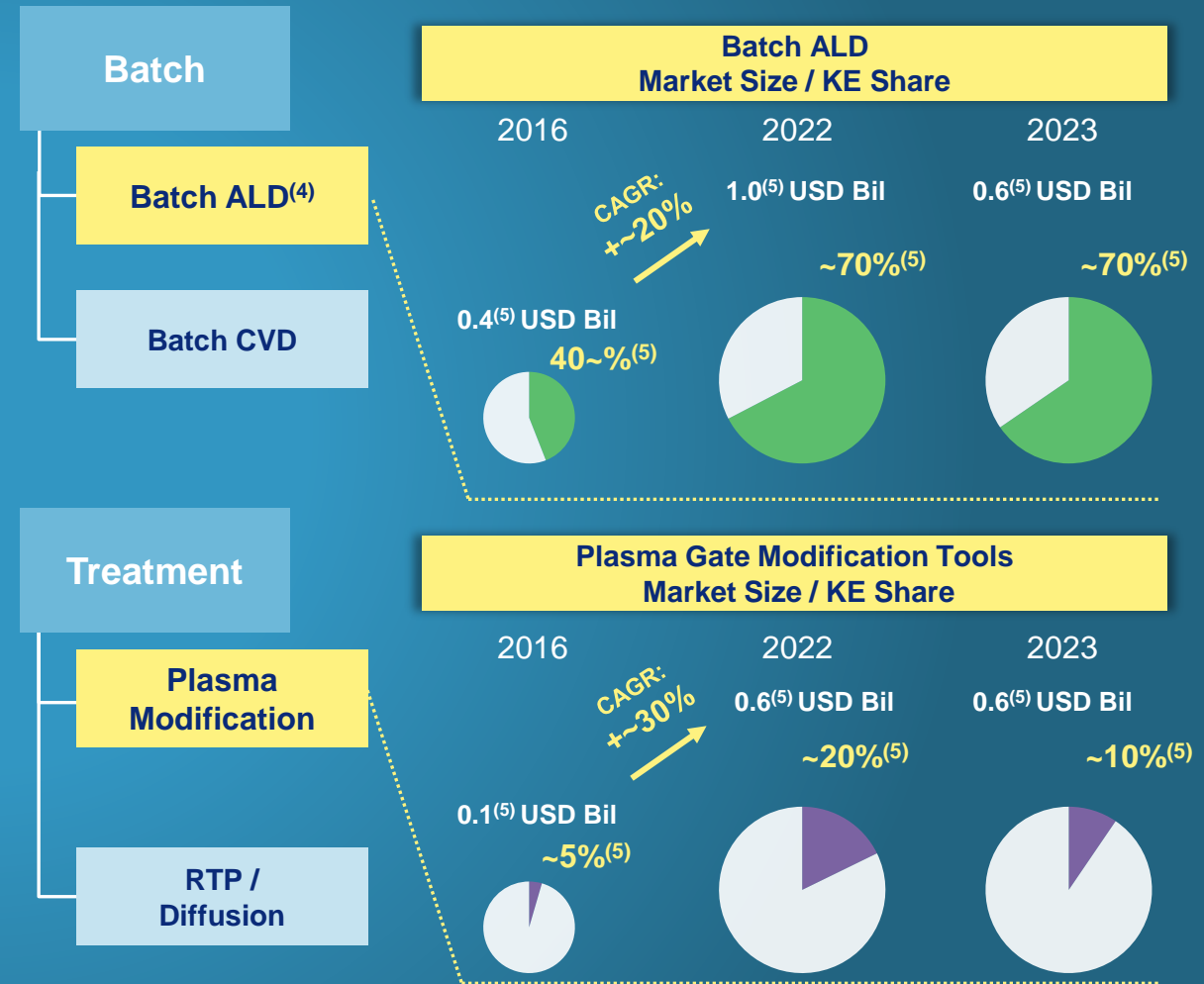

Notes:

1. Gartner®, Market Share: Semiconductor Wafer Fab Equipment, Worldwide, 2023, Bob Johnson, Gaurav Gupta, Menglin Cao, 1, May 2024

Graph/chart created by KE based on Gartner research, Gartner research, Calculations performed by KE. Treatment: RTP and Oxidation/Diffusion

GARTNER is a registered trademark and service mark of Gartner, Inc. and/or its affiliates in the U.S. and internationally and is used herein with permission. All rights reserved. Gartner does not endorse any vendor, product or service depicted in its research publications, and does not advise technology users to select only those vendors with the highest ratings or other designation. Gartner research publications consist of the opinions of Gartner's research organization and should not be construed as statements of fact. Gartner disclaims all warranties, expressed or implied, with respect to this research, including any warranties of merchantability or fitness for a particular purpose.

2. We define "Tube CVD" in Gartner's WFE segmentation as "Tube (Batch)" in this chart (Calculations performed by KOKUSAI ELECTRIC CORPORATION)

3. Total market in each of Gartner's category

4. We refer to a technique for thin-film deposition at an atomic layer level involving a process of cyclical supply of multiple gases as "ALD"

5. Kokusai estimate based on public information and internal sales data

Productivity Challenges of Deposition for Increasingly Complex and 3D Devices

3D Structure Requires High Productivity Deposition Tools, Capable of Conformal Thin Film Deposition onto Large Surface Area

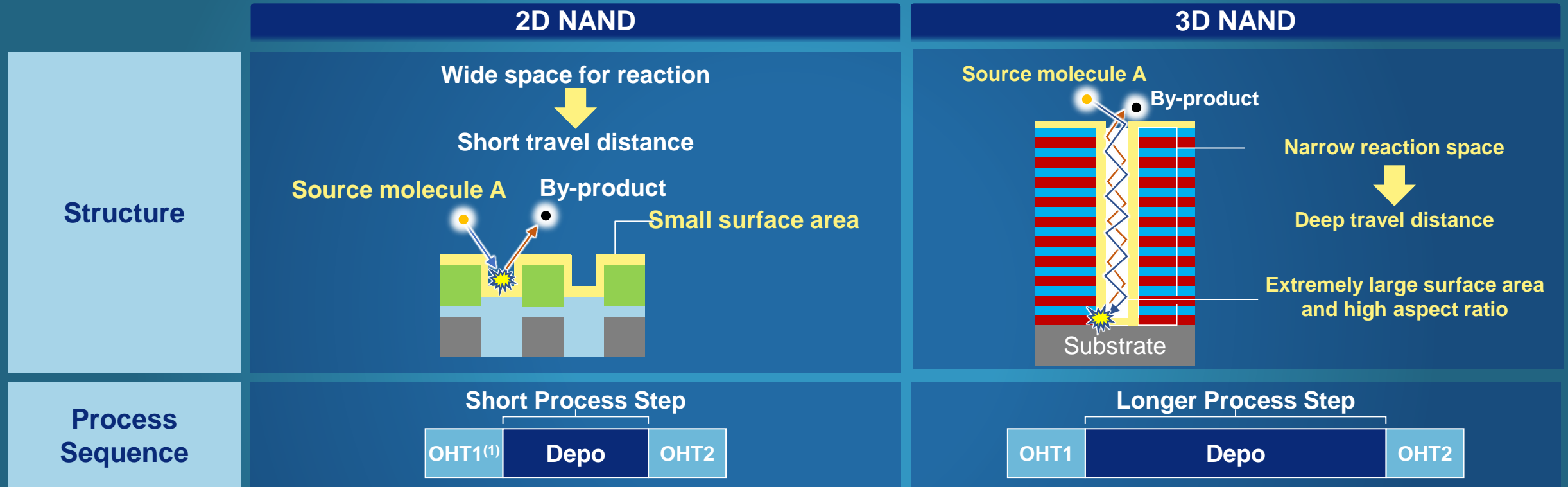

- ✓ Due to the shift of Device Structures from 2D to 3D, the productivity of the Deposition has become a severe challenge
- ✓ Batch technology is a solution to enable critical film deposition onto complex devices, achieving both film quality and high productivity

ALD – Key Solution to Achieve Conformal Deposition for Leading-Edge Devices

There Has Been a Demand Shift from CVD to ALD for Higher Film Quality, While ALD Has Productivity Issues

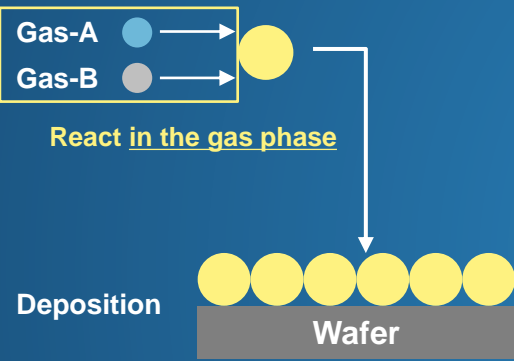
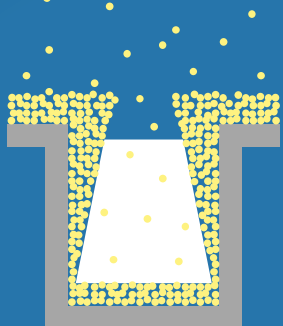
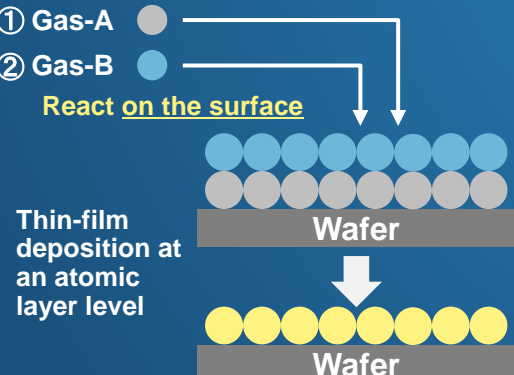
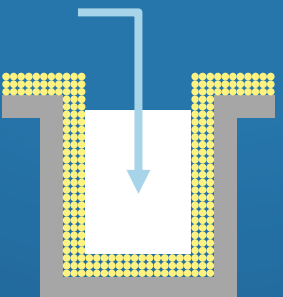
Method	Illustrative Process	Film on Trench	Feature
<p>CVD (Chemical Vapor Deposition)</p>	<p>Gasses are <u>simultaneously</u> flowed</p>  <p>React <u>in the gas phase</u></p> <p>Deposition</p> <p>Wafer</p>	 <p>React in the gas phase and deposits like snowfalls – Thickening on the Upper side of the Trench</p>	<ul style="list-style-type: none"> × Non-conformal Deposition × Poor Step Coverage × Poor Composition and Properties ✓ High Throughput ✓ Low Cost-of-Ownership
<p>ALD (Atomic Layer Deposition)</p>	<p>Gases are <u>alternately</u> flowed as part of <u>cyclic</u> processes</p> <ol style="list-style-type: none"> ① Gas-A ② Gas-B <p>React <u>on the surface</u></p> <p>Thin-film deposition at an atomic layer level</p>  <p>Wafer</p> <p>Wafer</p>	 <p>React on the surface - Capable of Conformal Thin Film Deposition</p>	<ul style="list-style-type: none"> ✓ Conformal Deposition ✓ Excellent Step Coverage ✓ Excellent Composition and Properties × Low Throughput × High Cost-of-Ownership

Comparison of Batch ALD Market and Single-Wafer ALD Market

ALD's Cyclic Process Requires Multiple Steps of Gas Supply and Exhaust, Causing Productivity Issues – Solved Well by Batch System

Batch is a Logical Combination with ALD – Complementary Relationship

Currently Not Much Overlap, While We Expect the Market Demands Shifting Towards Batch's Applications due to Device Complexity⁽¹⁾

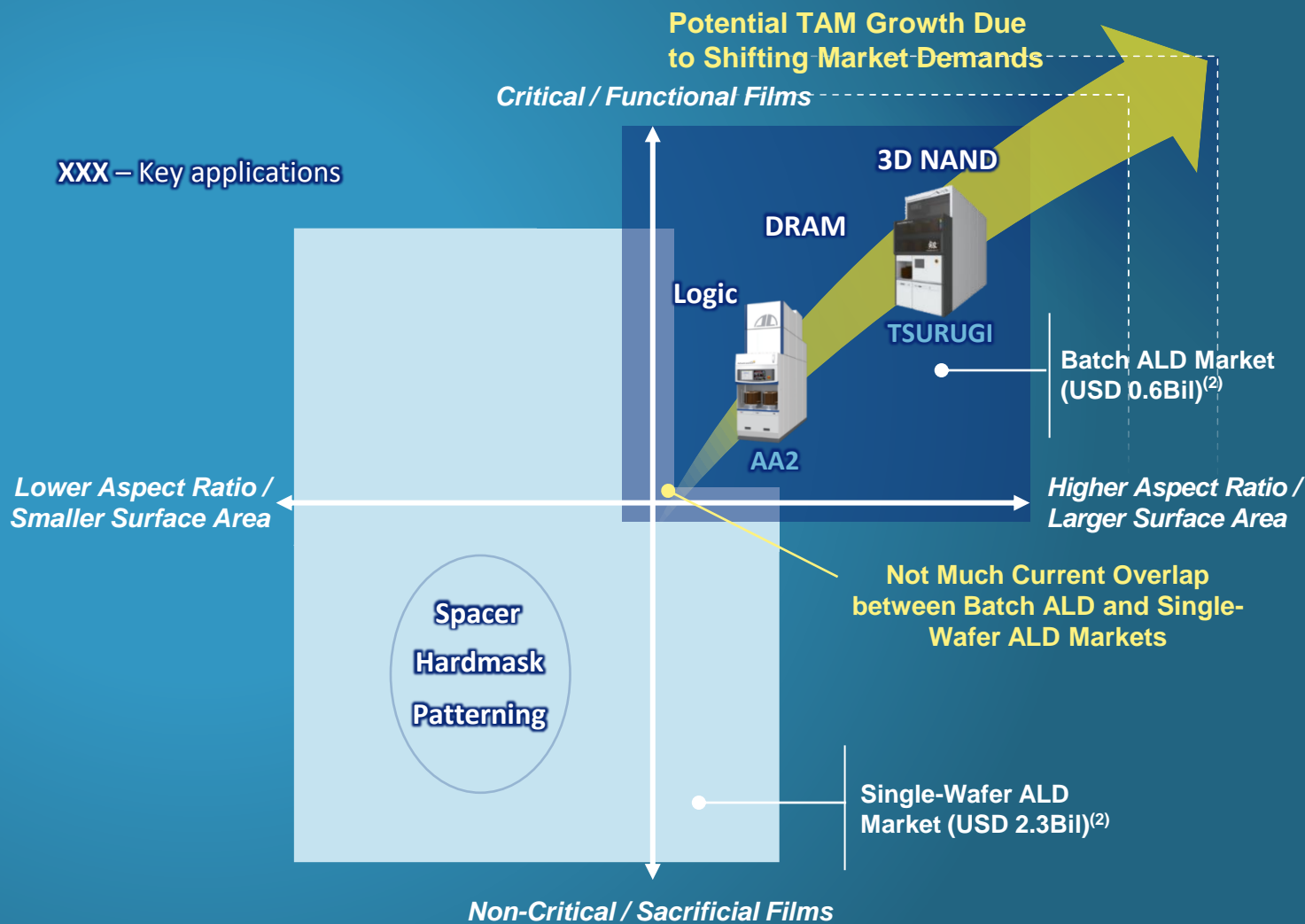
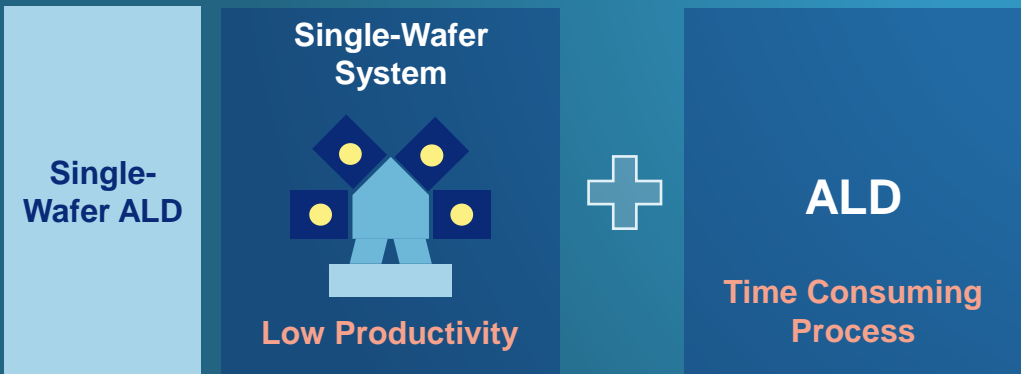
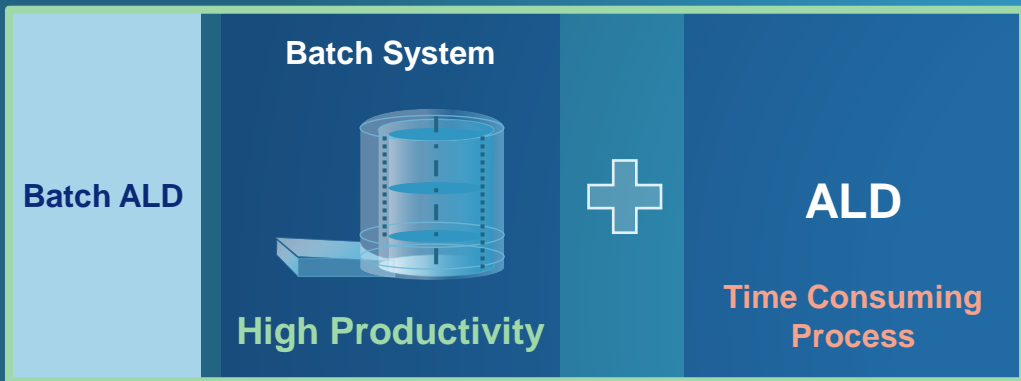

Near-Term and Mid-to-Long Term Catalysts⁽¹⁾ and Roadmap of KOKUSAI ELECTRIC

Memory to Keep Strong Position, Logic to Expand in GAA, and Additional Pillars such as Treatment and Power Device Tools

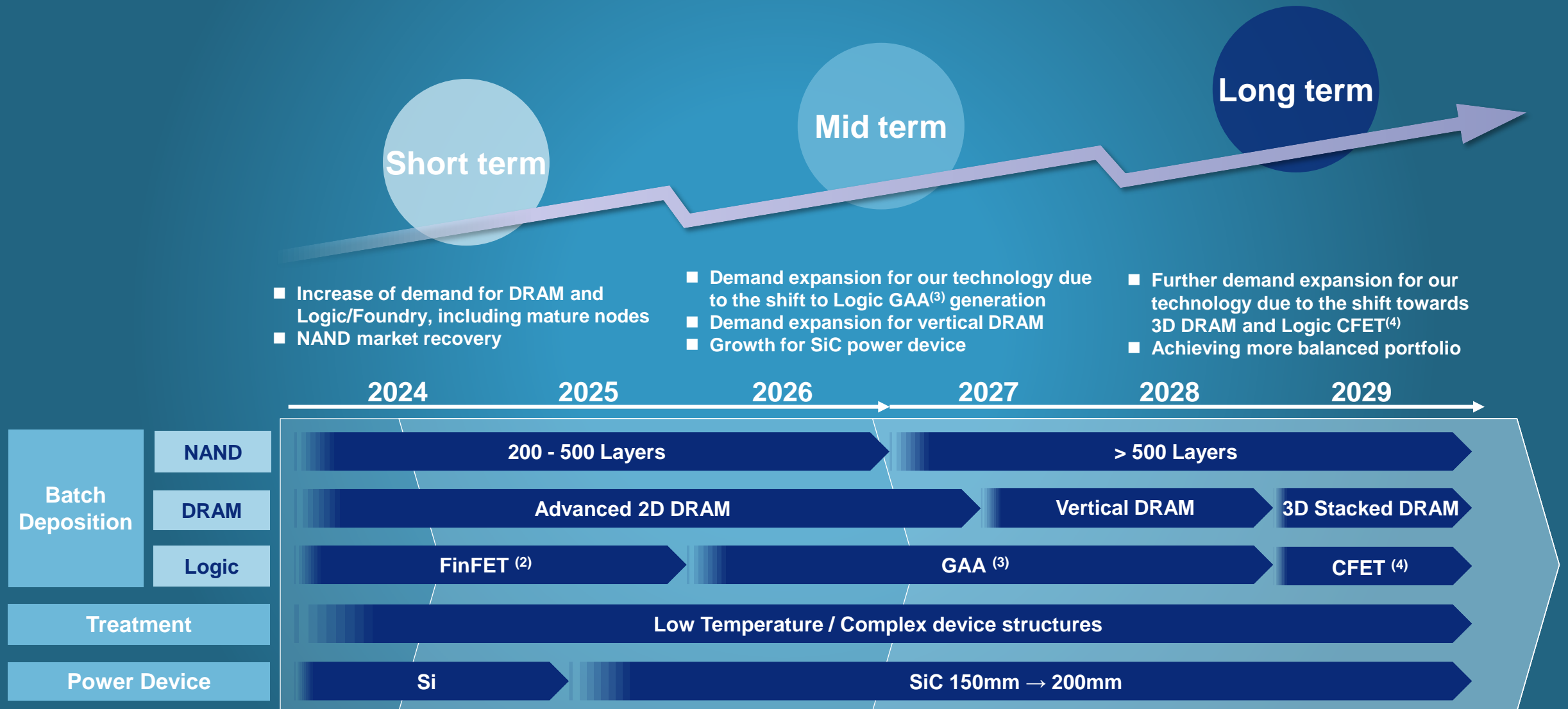

Notes:

1. KE Estimates
2. Fin Field-Effect Transistor
3. Gate All Around
4. Complimentary Field Effect Transistor

Equipment Revenue Breakdown by Application

Expecting NAND Market Recovery and Aiming to Further Expand New PORs⁽¹⁾ in DRAM and Logic

Breakdown of Equipment Revenue

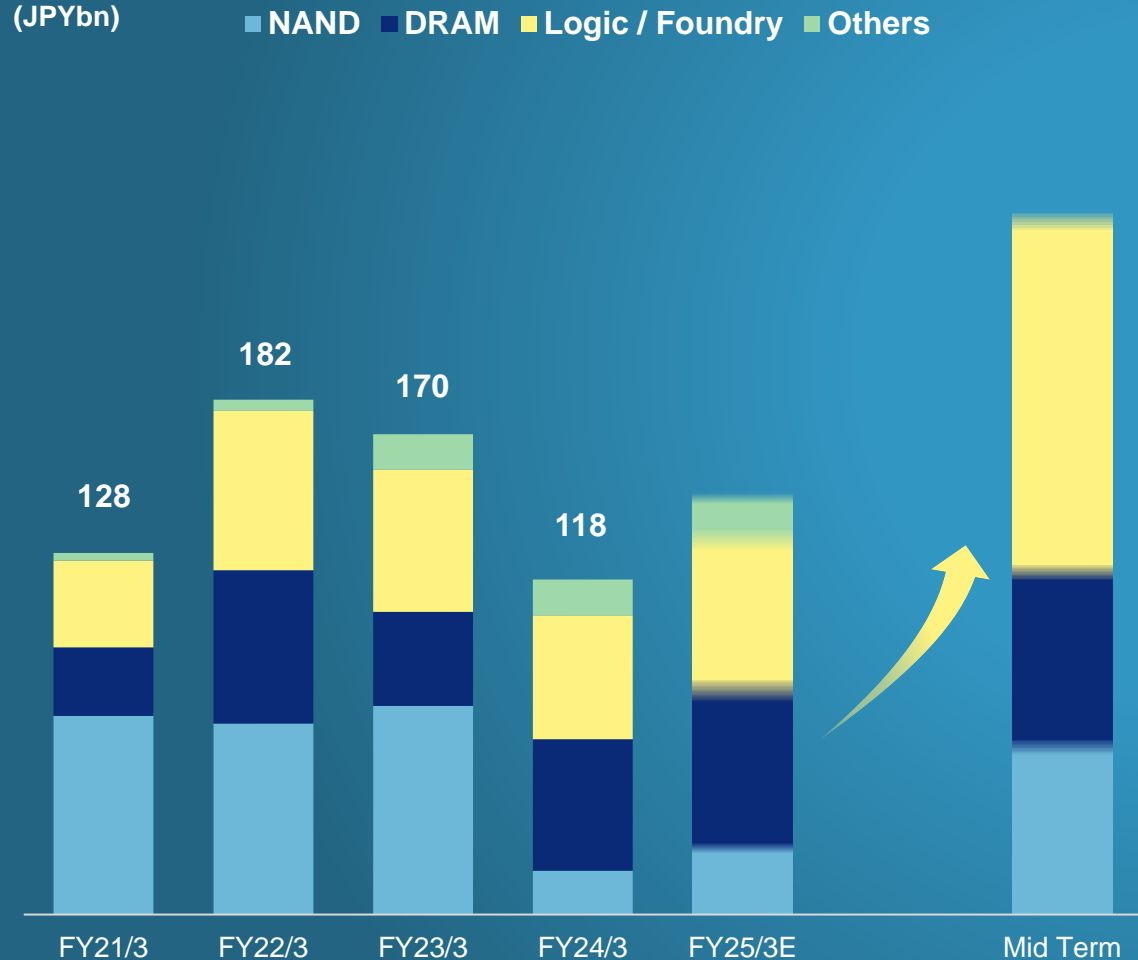

■ Overall

- Aiming for a well-balanced portfolio consisting of 50% Logic/Foundry and others, 25% DRAM, and 25% NAND in the mid-term

■ Logic/Foundry

- Aiming to expand our market share in GAA where we have acquired newly developed POR, and to further acquire new PORs in second-generation GAA
- Also aiming to expand revenues globally for mature nodes

■ DRAM

- Acquired new POR with high-difficulty film deposition of cutting edge DRAM
- Aiming for further new POR acquisition as TAM is expanding

■ NAND

- Already gained high market share in 3D NAND
- Expect market recovery and continuous growth with higher 3D stacking

Note:

1. POR: An abbreviation for Process of Record, which refers to the qualification of manufacturing equipment in a customer's semiconductor manufacturing process.



NAND

Shigeru Odake, Corporate VP
System Technology Development, Technical Support Center

Only Batch Can Achieve High Productivity in Case of High Aspect Ratio Deposition

Single-Wafer Could Achieve High Productivity in Lower Aspect Ratio with Short Cycle Time, While Low Productivity to High Aspect Ratio

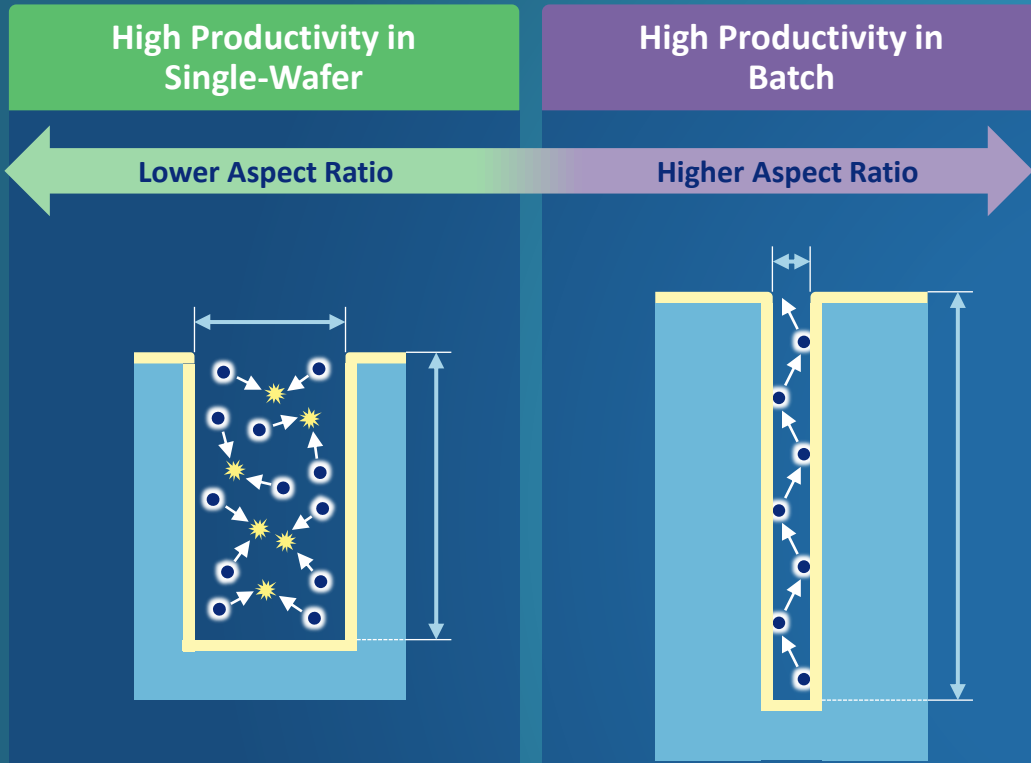

- Dominated by Molecular Diffusion**
- As memory holes widen, molecule to molecule collisions increase
 - Gas pressure difference is a key rate limiting factor, as molecules can move fast by changing the pressure quickly
 - Single wafer can improve productivity

- Dominated by Knudsen Diffusion**
- As memory holes become narrow, wall to molecule collisions increase
 - Time is an only rate limiting factor, as molecules cannot move fast even under different gas pressure
 - Only Batch can improve productivity

	Single-Wafer		Batch	
Batch Size	1		50 - 125	
Reactor Volume	Small		Large	
Aspect Ratio	Lower A/R	Higher A/R	Lower A/R	Higher A/R
Gas Change Rate	Short Cycle Time	Long Cycle Time	Long Cycle Time	Long Cycle Time
Productivity	High	Low	Medium	High
Comments	<ul style="list-style-type: none"> Single-Wafer can achieve high productivity in Lower aspect ratio with short cycle time 		<ul style="list-style-type: none"> Only batch is able to achieve high productivity in case of high aspect ratio Long Cycle Time disadvantage can be offset by Batch Size 	

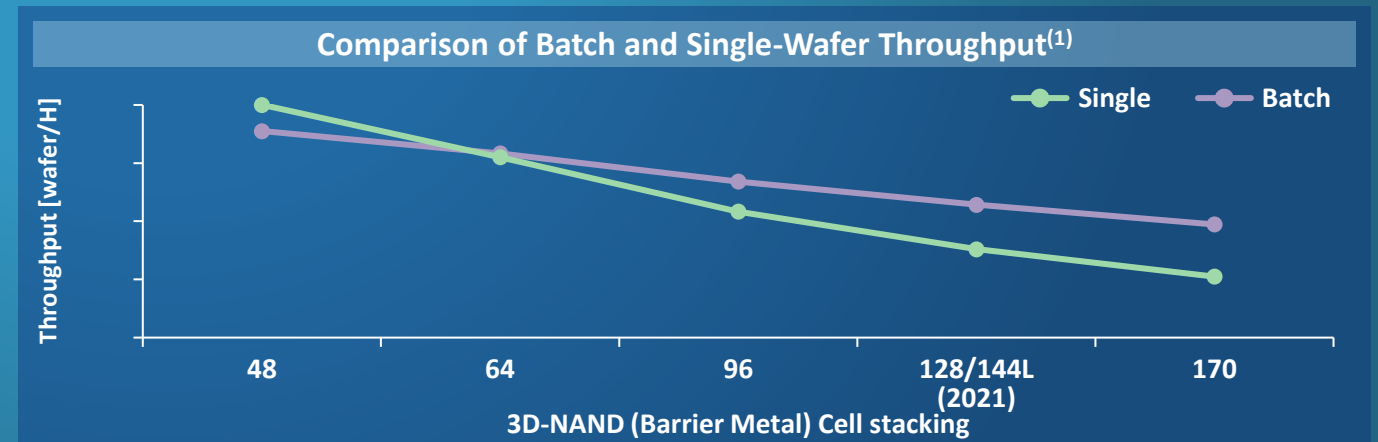

TSURUGI Enables Both Complex Structure Depositions and High Productivity

Optimum Design of Gas Inflow and Exhaust Control Provides the Best Solution to the Complex Structure

Improved Productivity by Reducing Process Time

65% Process Time Reduction

Large Batch (QUIXACE)



Mini Batch (TSURUGI)



1 Overhead Time (OHT1&2)

- Shorter heating and cooling time by reducing tube volume

2 Deposition (Depo)

- Faster gas inflow and exhaust time by reducing tube volume
- Increase gas volume to minimize gas inflow time
- Shorter exhaust time by lowering pressure

1

Smaller Tube Volume

- Temperature control: Reduction of heating and cooling time
- Improve gas inflow and exhaust time

Large Batch

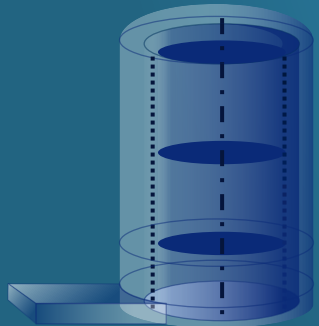

TSURUGI

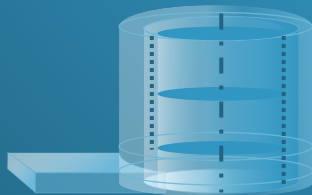

Increase in Gas Flow

- Fast gas inflow time

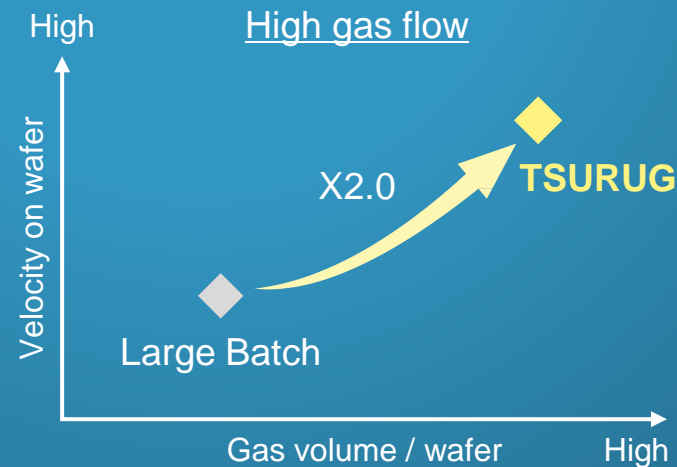

2

Lower Pressure

- Decreased exhaust time

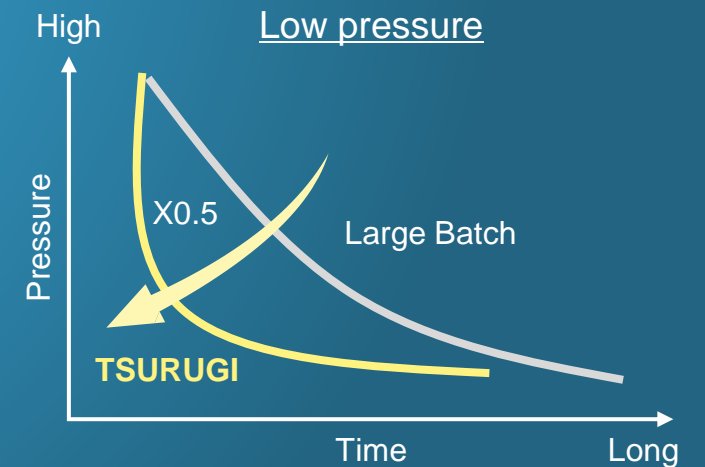

Leading Positions in 3D NAND Memory CELL Applications

Further Expanding our Share through Active Evaluation in the Remaining Processes where Competitors had been Adopted

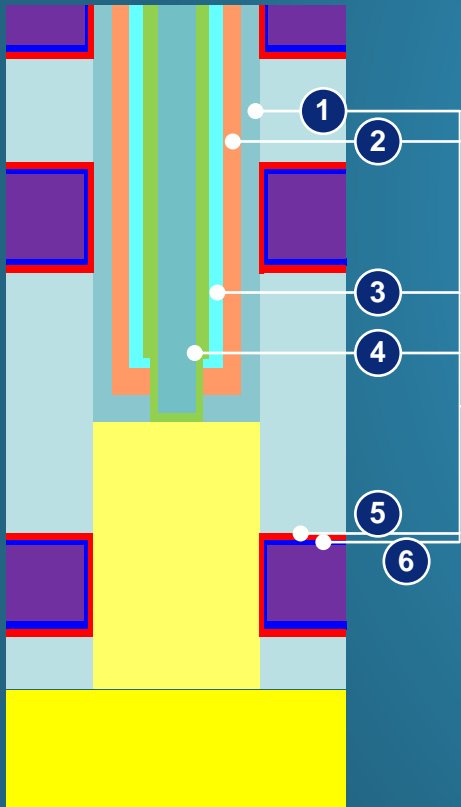

Process	KE POR Share ~200 layers	KE POR Share 200~500 layers	KE POR Share 500 layers ~
① Blocking Oxide	✓✓✓✓✓	✓✓✓✓✓	✓✓✓✓✓
② Charge Trap Nitride	✓✓✓✓✓	✓✓✓✓✓	✓✓✓✓✓
③ Tunnel Dielectric	✓✓✓✓✓	✓✓✓✓✓	✓✓✓✓✓
④ Channel Si (×2) ⁽³⁾	✓✓	✓✓✓	✓✓✓✓
⑤ Blocking Metal Oxide A	✓	✓✓	✓✓✓
⑥ Barrier Metal A	✓	✓✓	✓✓✓

Notes:
 1. Company Information
 2. KE estimates
 3. Channel Si has two processes



DRAM

Shigeru Odake, Corporate VP
System Technology Development, Technical Support Center

Expanding New PORs in DRAM with an HBM Tailwind

DRAM Market Share Expected to Grow as Devices Evolve into the Next Generation

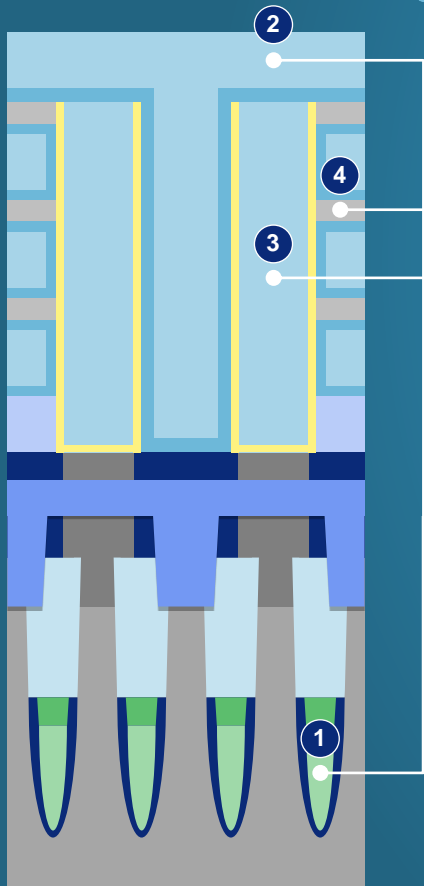
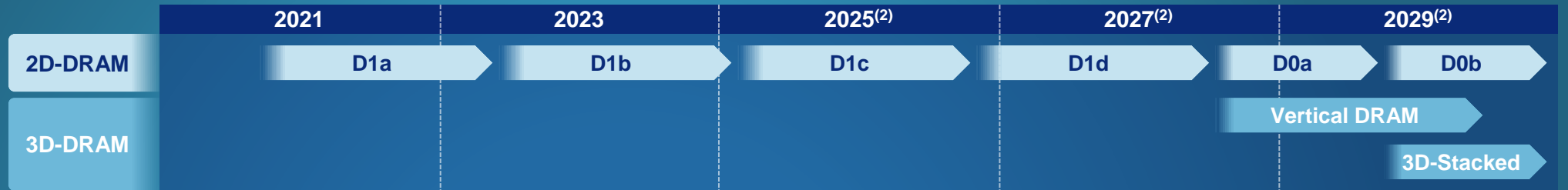

	D1a	D1b	D1c	D1d
1 bWL Treatment	✓ ✓ ✓	✓ ✓ ✓ ✓ ✓	✓ ✓ ✓ ✓ ✓	✓ ✓ ✓ ✓ ✓
2 Top Electrode	✓	✓	✓ ✓ ✓	✓ ✓ ✓ ✓ ✓
3 Bottom Electrode Treatment	✓	✓ ✓ ✓	✓ ✓ ✓	✓ ✓ ✓ ✓ ✓
4 Cylinder Support	—	✓	✓ ✓ ✓	✓ ✓ ✓ ✓ ✓

Notes:
 1. Company Information
 2. KE estimates

Structural Shift of DRAM towards Next Generations

The Same Structural Shift as 3D NAND Going to Happen in DRAM in 2 Steps – Vertical DRAM and 3D DRAM

Advanced 2D DRAM → Vertical DRAM

(Bit Line is placed directly under the channel)

- New POR opportunity for Bit Line
- As die shrink progresses, the distance between Bit Line and Word Line becomes closer, increasing the need for stray capacity reduction and opportunity of using Low-k dielectric

Vertical DRAM → 3D-Stacked DRAM

(Channel direction is rotated by 90 degrees from Vertical DRAM)

- Increase in Lateral Deposition
- Increase in embedding processes
- Increasing Treatment demand with a need to supply sufficient radicals horizontally

Advanced 2D-DRAM

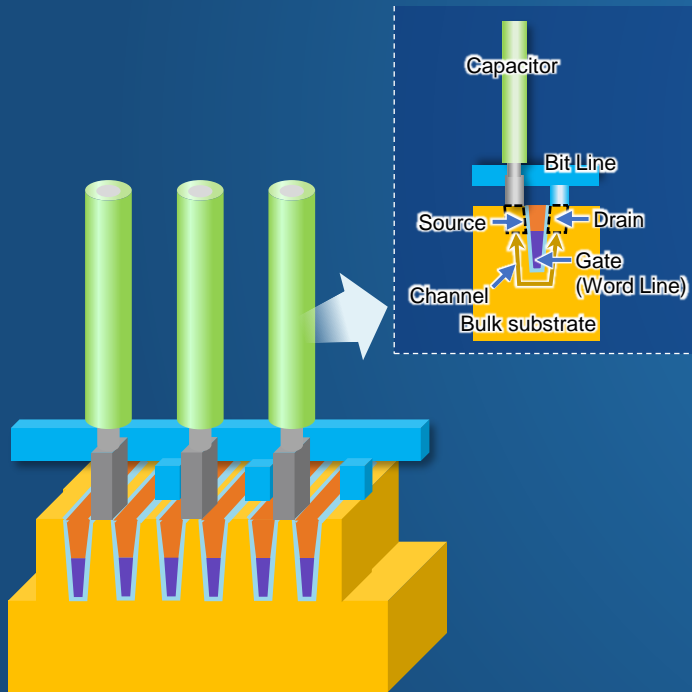

Vertical DRAM

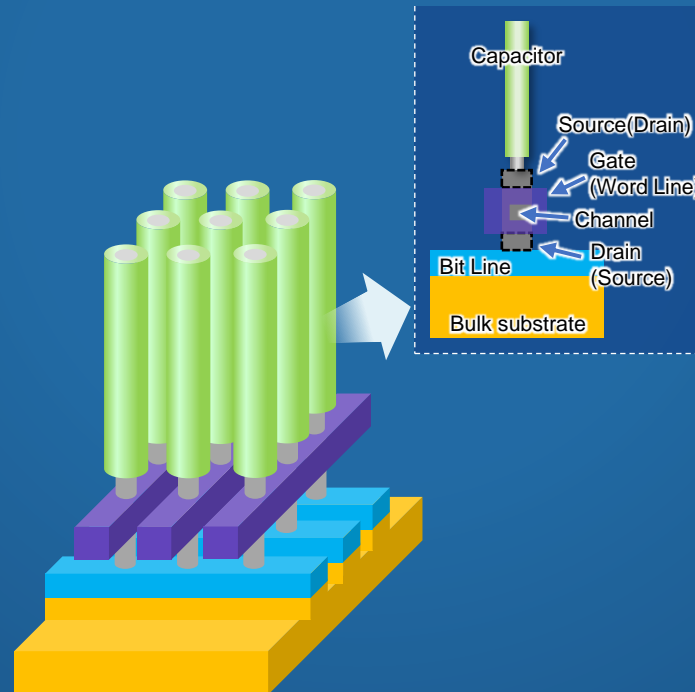

3D-Stacked DRAM





Logic

Kenji Kanayama, Senior VP
Technology Management, Process Technology Development

Strong Momentum in GAA, and Next Inflection Point towards CFET

Already Received PORs in GAA and Further Expanding PORs - CFET's 3D Structures would Require More Batch Processes

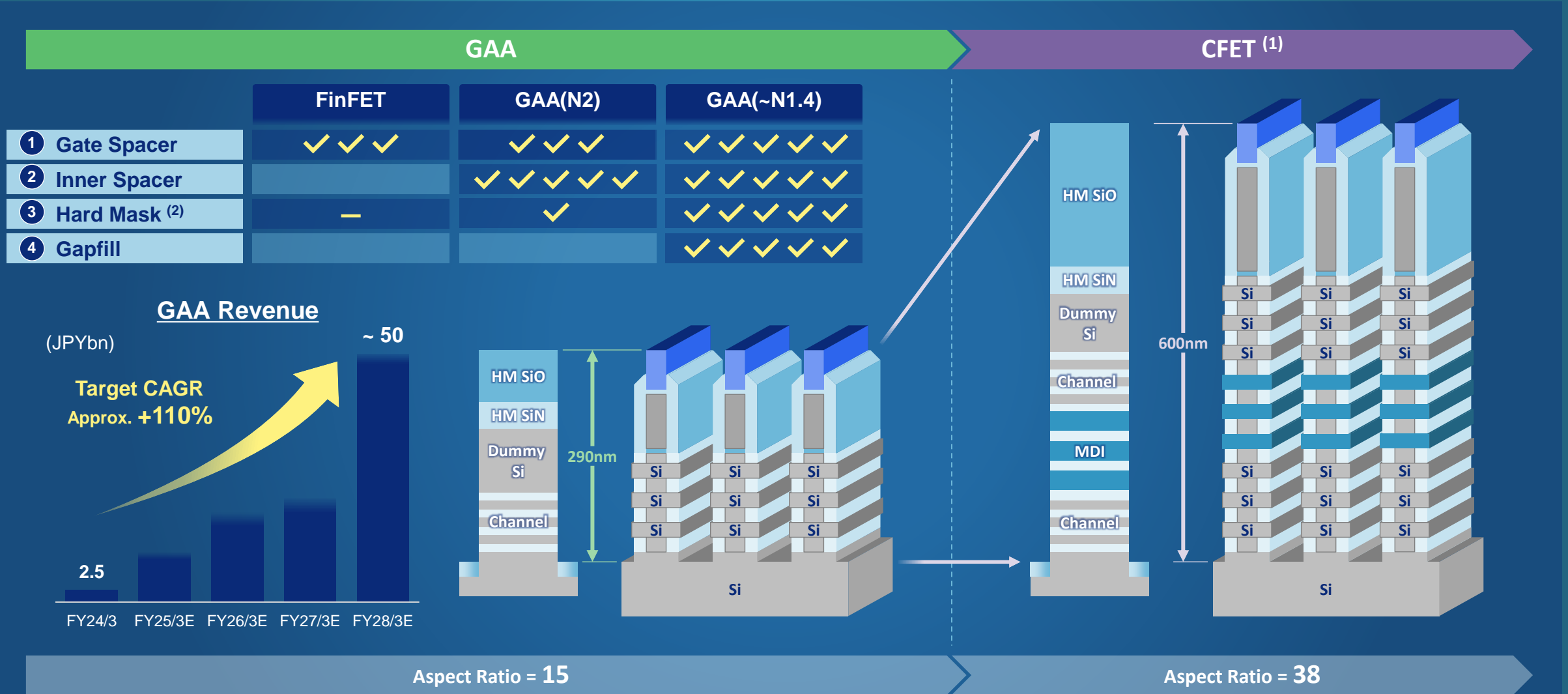

Notes:
 1. imec
 2. Hard Mask for Nano sheet protection

New Application in Silicon Interposer

On Top of Applications in Leading-edge DRAM and Logic, Our Batch ALD Application Has Expanded to Si Interposer

Deep Trench Capacitor in Si Interposer

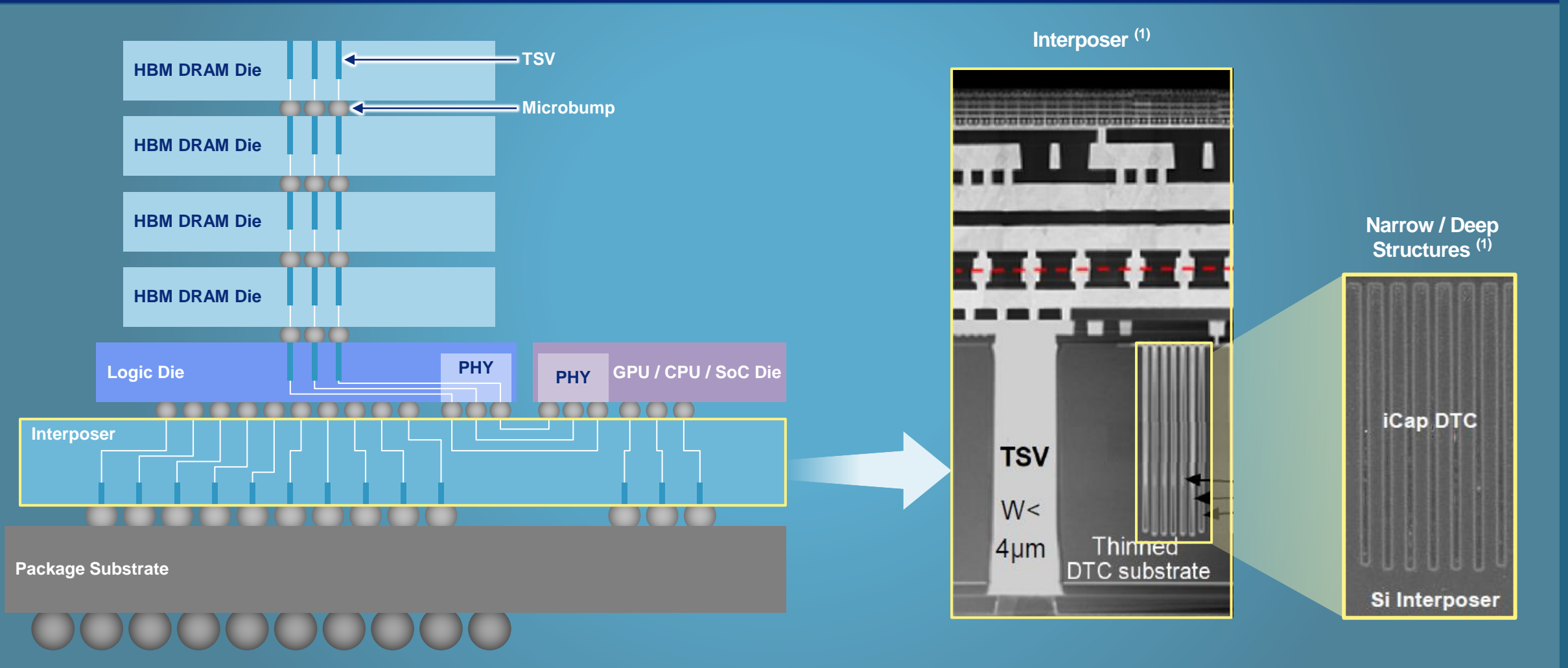

Note:

1. S. Felix et al. Wafer-Level Stacking of High-Density Capacitors to Enhance the Performance of a Large Multicore Processor for Machine Learning Applications, ISSCC2023

Expanding Mature Logic in Europe and the U.S.

Proven Success in China and Japan, Further Expanding into Europe and the U.S. to Achieve More Stable Revenue Base

Our Products for Mature Logic

Batch Thermal Processing Products of 300mm Wafers

High Productivity
Large Batch System
“AdvancedAce®-300”



High Productivity
Large Batch System
“QUIXACE®-II”



- Over 10,000 delivery record
- Variety of batch process platforms available

Features and Benefits of KOKUSAI Batch Thermal Process Solution

Process Performance

High Productivity

Human Friendly
Technology

Sustainability
Technology

Compact Footprint

Lead Time Flexibility

Expanding Mature Logic in Asia, Europe, and the U.S.

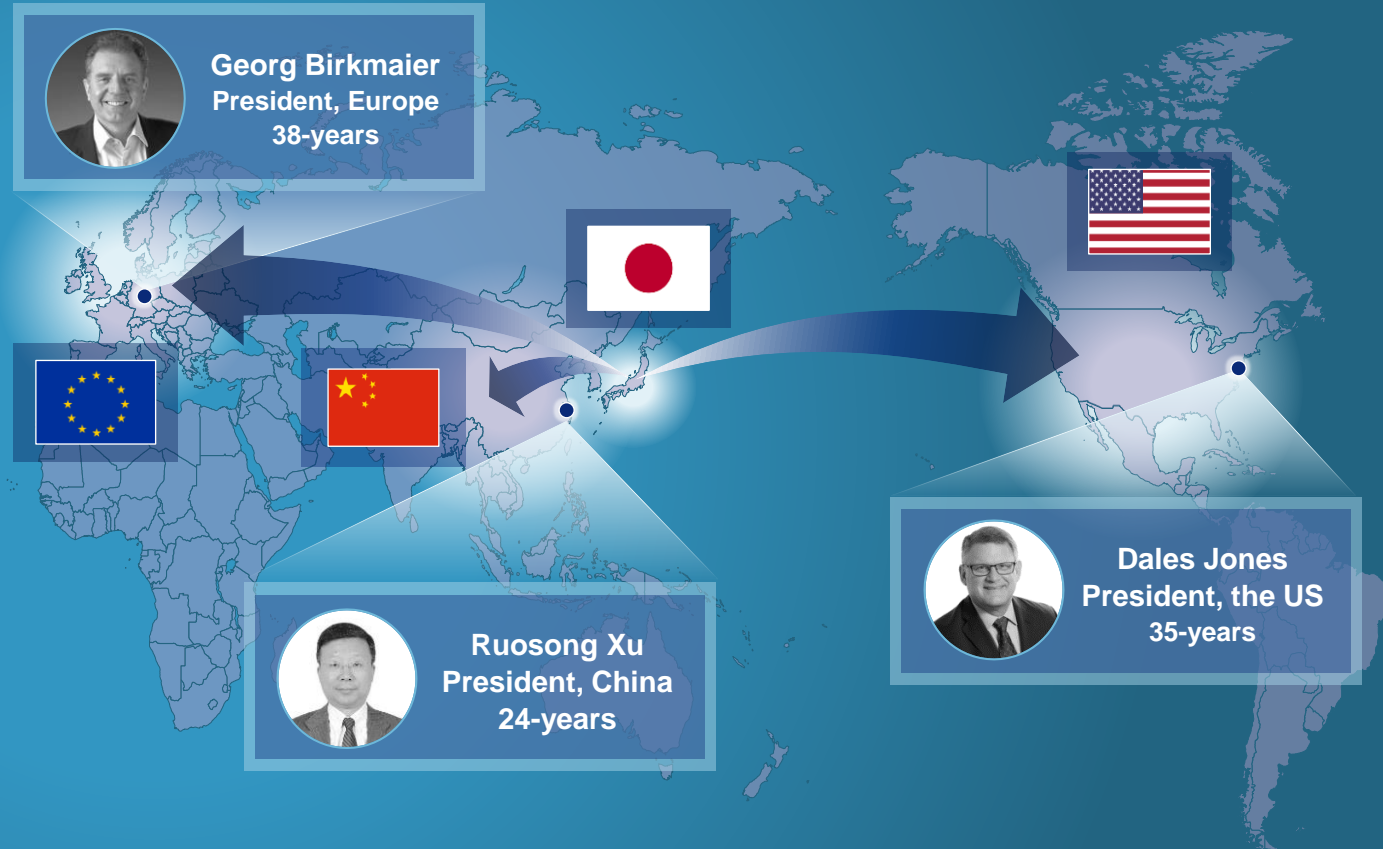

**Achieving More Stable Revenue Base
Through Geographical Diversification,**



Treatment

Kenji Kanayama, Senior VP
Technology Management, Process Technology Development

MARORA's Advantages Aligned to Shifting Market Demand - Device Complexity and Lower Temperature

MARORA Has Been Adopted in 3D NAND and DRAM with Wide Process Temperature and Excellent Step Coverage

Single-wafer treatment
MARORA[®]



Wide Temperature Range

Excellent Step Coverage in a Deep Hole

- 1** *Demand for deposition in low-temperature environment has increased due to device complexity*
- 2** *Degradation of film quality in low-temperature environments due to insufficient heat*
- 3** *Increasing demand for treatment that improve film quality in low-temperature environments to improve the quality of existing films*
- 4** *In such an environment, MARORA has advantages in wide temperature range and excellent step coverage in high aspect ratio structures and is expanding PORs*

Proven Success as a Solution for Maintaining Film Quality in Complex Device Structure

Already Strong Positions in NAND and DRAM, and Further Expanding across All Major Customers

NAND

Blocking Oxide damage cure

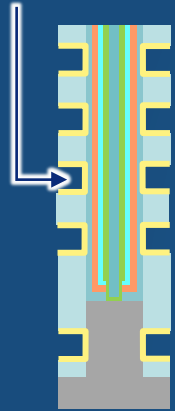

Competitor



Poor step coverage

MARORA



Excellent step coverage

- Already acquired multiple PORs in 3D NAND
- Treatment process increases as layering progresses
- Developing new treatment methods such as cure on top of Oxidation
- Active evaluation with major customers, introducing JDP Tools

DRAM

Capacitor Bottom Electrode cure

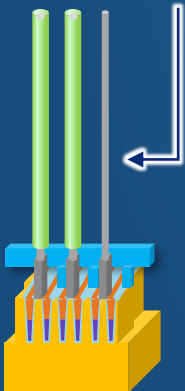

Competitor



Poor step coverage

MARORA



Excellent step coverage

- Acquired PORs with DRAM customers in Bottom Electrode
- In addition to Nitridization of Bottom Electrode, evaluating new processes such as metal cure and selective oxidation with an HBM tailwind
- Active evaluation with major customers, introducing JDP Tools

Revenue in MARORA

(JPYbn)

Target CAGR
Approx. +50%

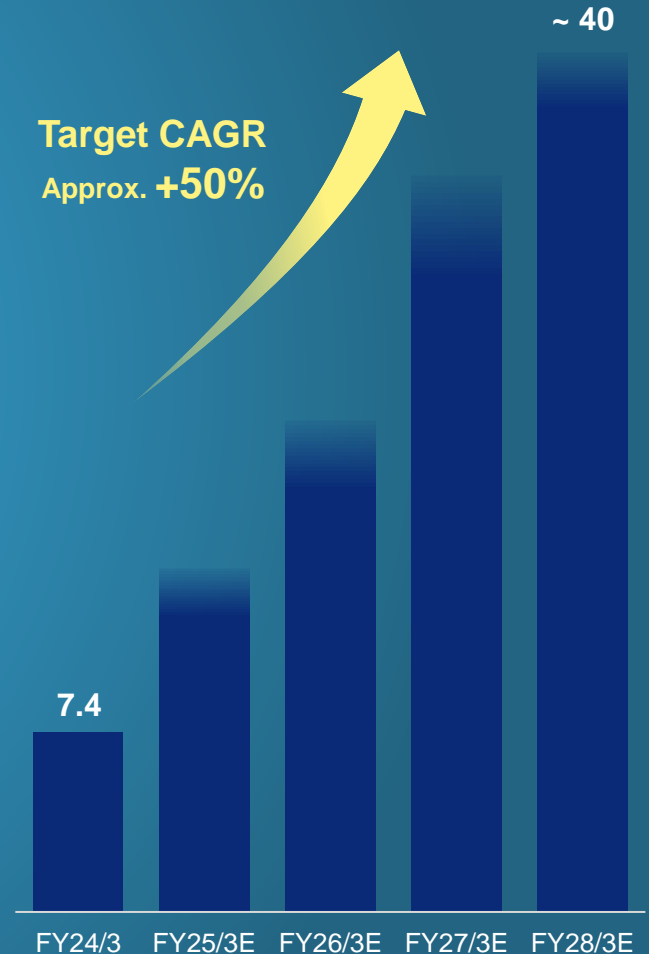



Service

Naotoshi Yamamine, Senior VP
Services, Field Engineering, Group Governance

Expanding Service Business as a Source of Recurring, Stable and Higher-Margin Revenue

Achieved strong growth in Service revenue through resilience even in downcycles

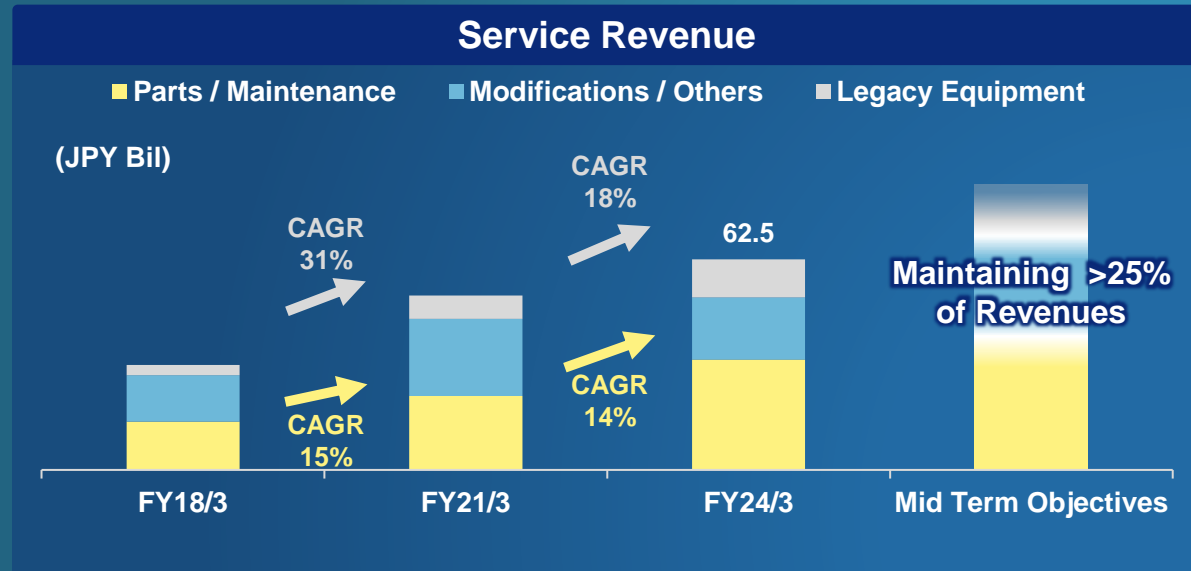

- Conduct a “Design for service business⁽¹⁾” to increase revenue
- Lock-in key customers’ spare parts and service contracts in an early stage of product release
- Expand 200mm business with Brand-New Platform
- Modification of old equipment to maximize life-time value

Growth Strategy of Parts/Maintenance Revenue

Increase Install Base by Expanding Equipment Sales



Increase Sales per Unit by “Design for Service Business”

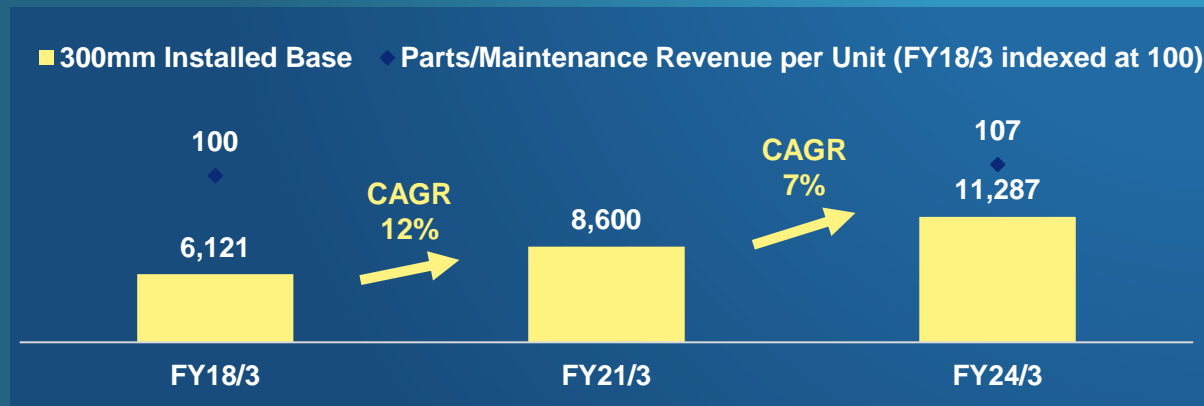

Effect of “Design for Service Business”

	“Design for Service Business”	Parts / Maintenance Revenue per Unit	Revenue CAGR (FY17/3-FY23/3)
Conventional Tools	n/a	1x	Approx. 20%
A-TSURUGI / TSURUGI	Adopted	4x~	Approx. 75%

Note:
1. Design for Service Business (DISB): Identify important parts in the Service business at the product development stage, and create devices in advance to prevent counterfeits through patent and design rights, and special KE specifications

Expansion of Service Business Foundation

Establishing new sites in Dresden and Kaohsiung and a subsidiary in Singapore

Global Service Network (35 Sites & 11 Planned Sites in 10 Countries) ⁽¹⁾

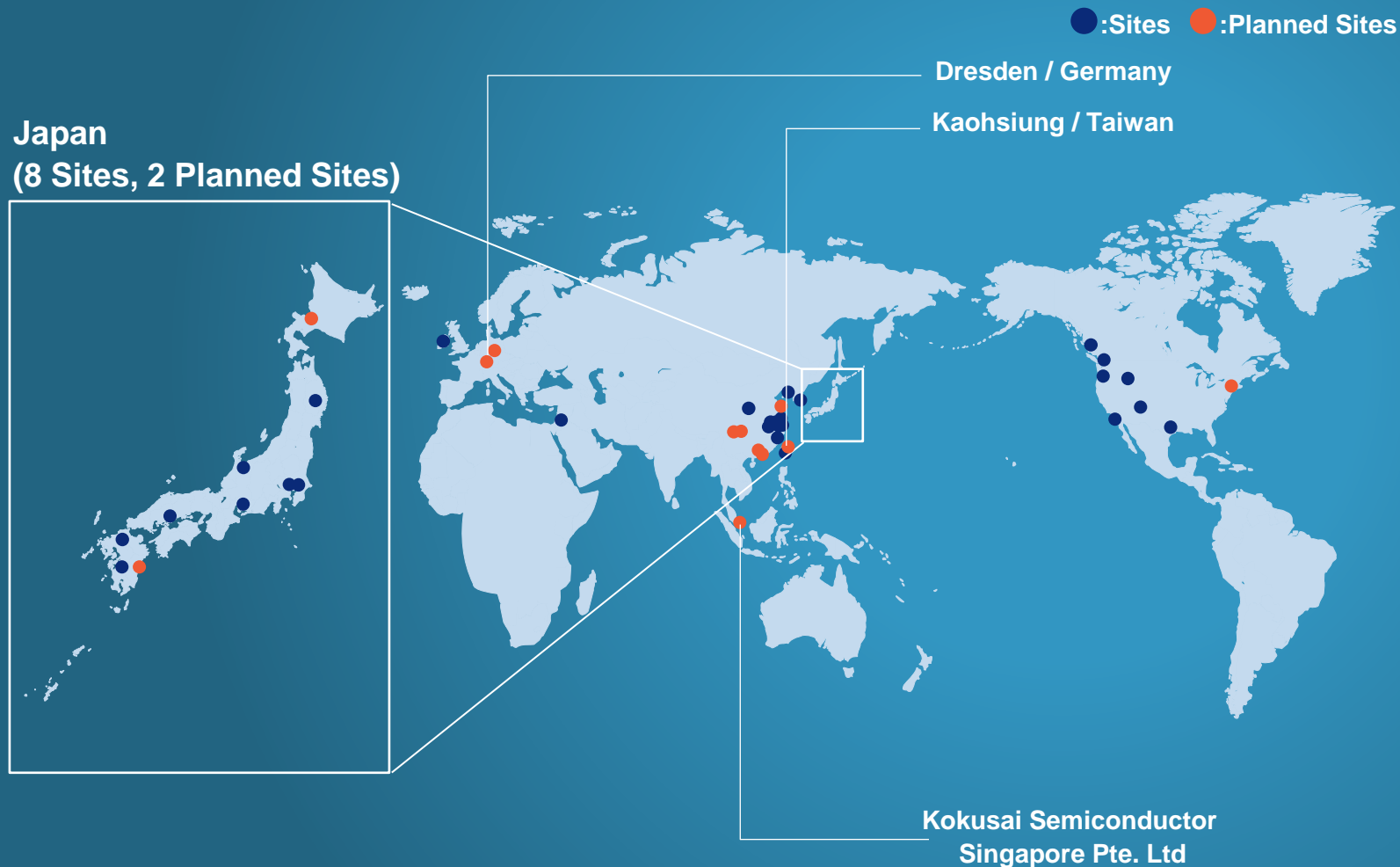

Strategy of New Service Network

Dresden & Kaohsiung Service Center



- Strategically expanding business by opening service sites near key customer factories

KESG

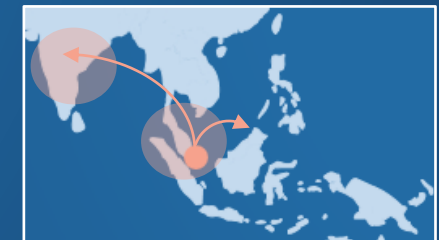

- Expanding business in Southeast Asia, including Singapore and Malaysia, as well as South Asia, such as India, and strengthening the service support system

Note:
1. As of June, 2024

SiC Power Devices: Strong Revenue Growth Boosted by Market Expansion

Aiming for steady POR acquisitions mainly for 200mm equipment

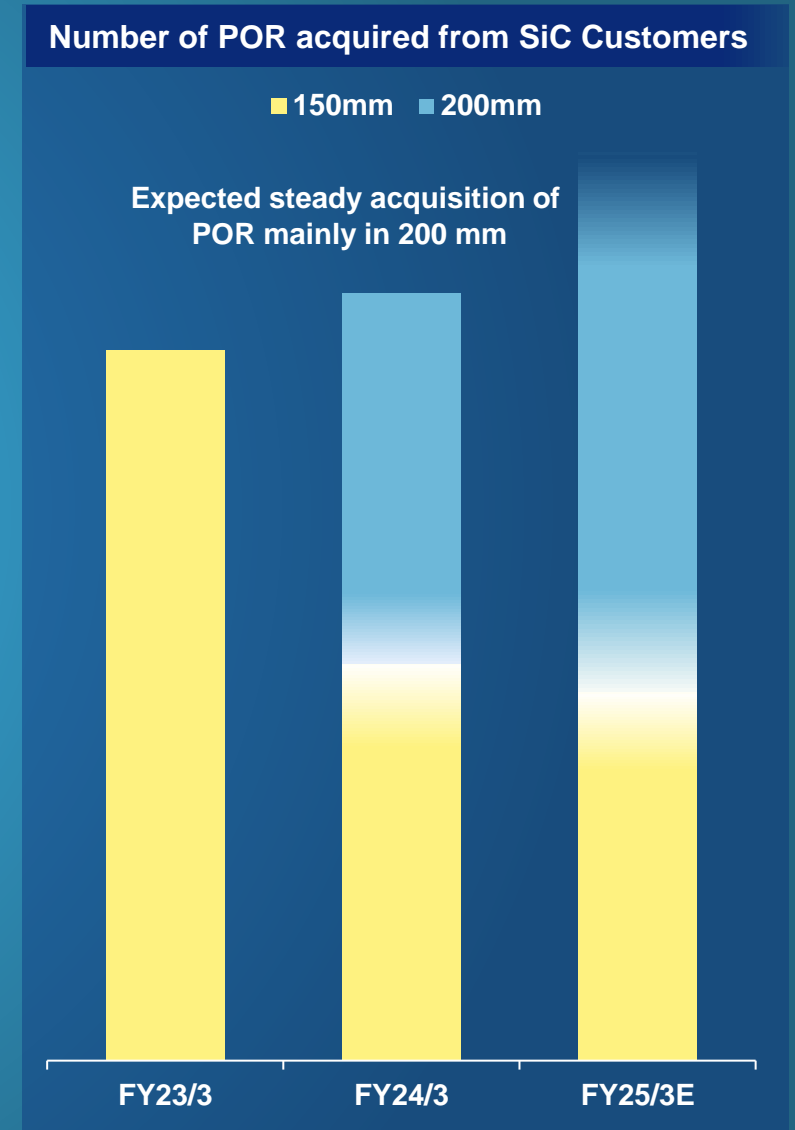
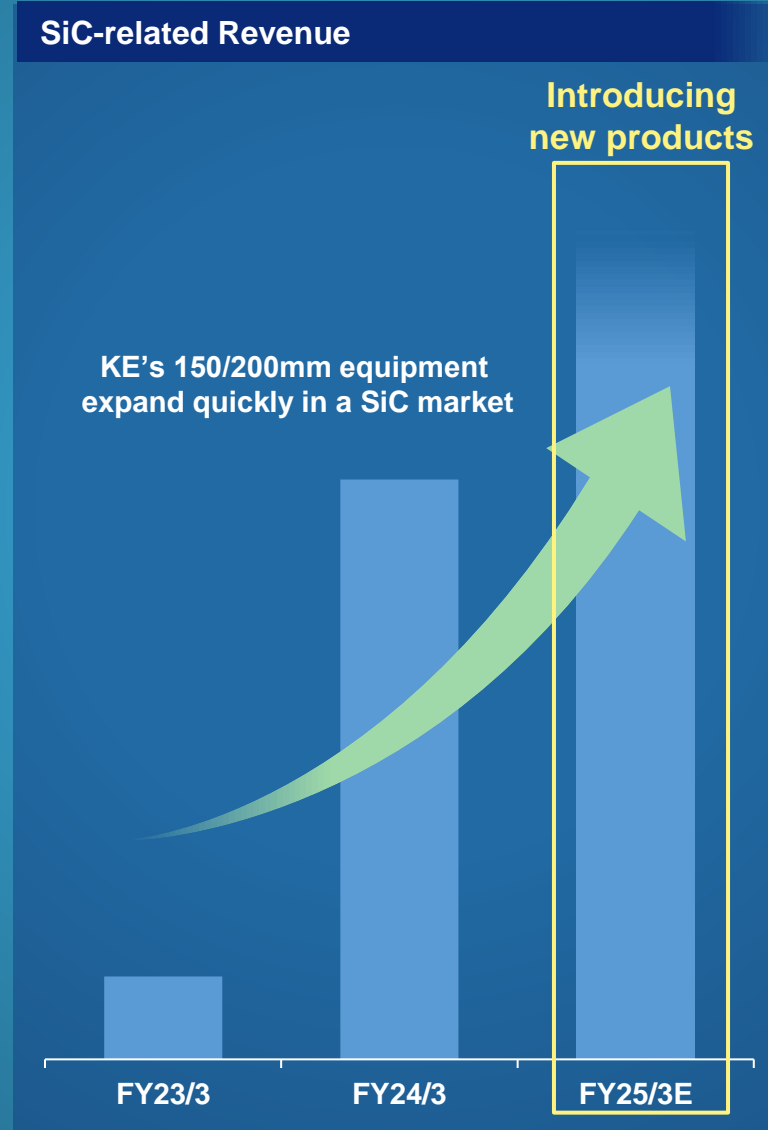

Note:
1. FUJI KEIZAI CO., LTD. "2024 Current status and future outlook of markets for power devices and power electronics-related equipment"

Strengths of KE's Equipment for SiC Power Devices

Customers value KE's new products for SiC power devices as well as contribution to improved productivity, leading to POR acquisitions

Contribution to Productivity Improvement

Vertical Batch Common platform for various thermal processes

SiC MOS-FET(Trench-Gate)	SiC MOS-FET process	KE's Application	Supplier A	Supplier B
	① Diffusion layer	✓		✓
	② Trench shape formation	✓	✓	
	③ Gate insulator	✓		✓
	④ Gate electrode	✓	✓	
	⑤ Inner layer	✓	✓	
	⑥ Metal layer	✓	✓	
	⑦ Passivation	✓	✓	
	⑧ Back metal layer	✓	✓	

VERTRON® Revolution

- Standardization of user interface across common platform
- Consistency in maintenance work
- Inventory cost optimization through standardization of spare parts
- Reduction in scrap costs of expensive SiC wafers with WPS(Wafer Protection System)



Thermal Solutions for SiC Power Devices

High Temp Activation Anneal ~ 2,000C

- High productivity with processing
- Induction heating significantly improves power consumption
- Temperature control and measurement inside the reactor tube
- Reliability (VERTRON® Revolution Platform)

High Temp Oxy-Nitride Anneal ~ 1,400C

- High productivity with processing
- Long-lasting heater system
- Excellent film thickness uniformity and low contamination
- Reliability (VERTRON® Revolution Platform)

Maintenance Solutions

Long PM Poly Si

- Extend PM(Preventive Maintenance) cycle for Poly Si
- Improve equipment uptime and reduction in PM costs

Accumulated thickness for PM Cycle

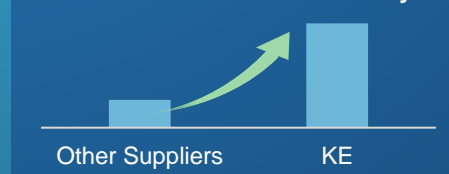

New Deposition Solutions

ALD-SiO

- Technology used as the gate oxide film for the next generation
- Leveraging our expertise in ALD technology to acquire POR moving forward



Global Operation

Masayuki Yamada, Senior VP
Head of Global Supply Chain, Quality Assurance, Site Operations

Global Production Sites and Capacity

The New Factory is Expected to Start Operating this Fall, Significantly Increasing Production Capacity

Global Production Sites (Japan and South Korea)



Cheonan Factory



Toyama Factory

Tonami Factory (Under Construction)

✓ Scheduled to start operation
in October 2024



Expanding Production Capacity

**Approx. +100% in FY26/3
compared to FY21/3⁽¹⁾**
The opening of the Tonami factory will lead to a doubling of production capacity

**Sufficient capacity
to meet WFE market growth**

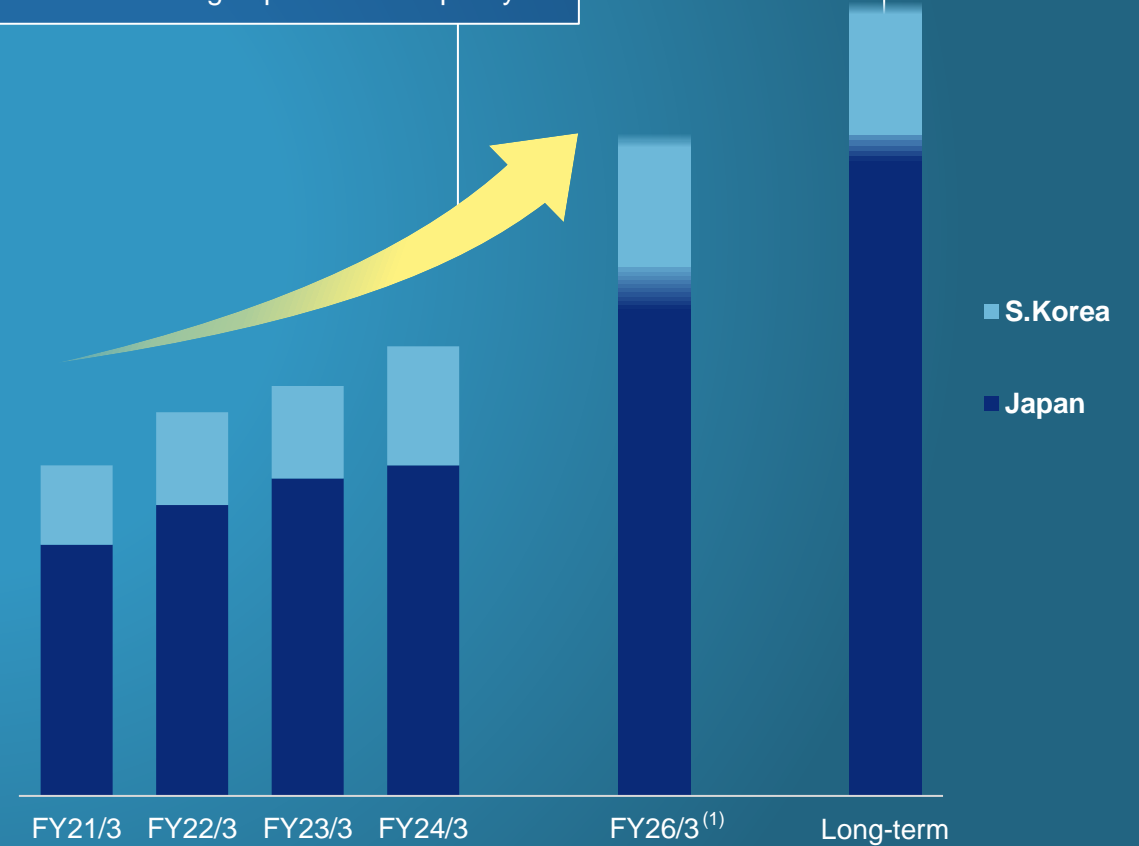

Overview and Concept of the New Factory (Tonami)

In the New Factory, We Aim for More than Twice the Traditional Production Efficiency through Smart Transformation (SX)⁽¹⁾

New Factory Overview⁽²⁾



Name	Tonami Factory (Provisional)
Address	Shimonakajou, Tonami City, Toyama Prefecture
Site Area	Approx. 40,000 square meters
Construction Cost	Approx. JPY 24bn
Use / Purpose	Manufacturing and R&D of semiconductor manufacturing equipment

Tonami Factory – SFX 200⁽³⁾ Concept



Notes:

1. Transformation activities towards smart production and management utilizing cutting-edge technology and data from IoT, IT, and digitalization
2. CG (computer graphics) image as picture
3. Project name refers to concept of increasing production capacity by 200% through Smart Factory Transformation
4. Production efficiency refers to production capacity per certain unit of equipment installation area. Production efficiency in Toyama factory in FY21/3 serves as benchmark

Tonami Factory Concept – Production Efficiency Goals through SX

Space-saving in Production Area and Higher Turnover Rate will Drive Efficiency Improvements

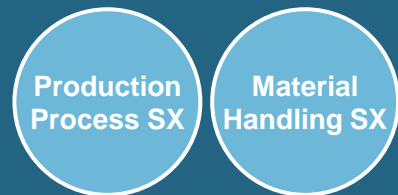

Production Efficiency Goals

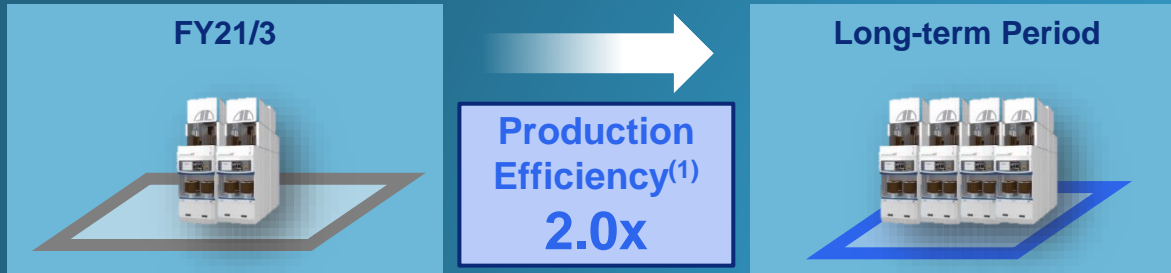

- 1 Improvement of Space Utilization Efficiency in Production
Measures: Adoption of a new production method

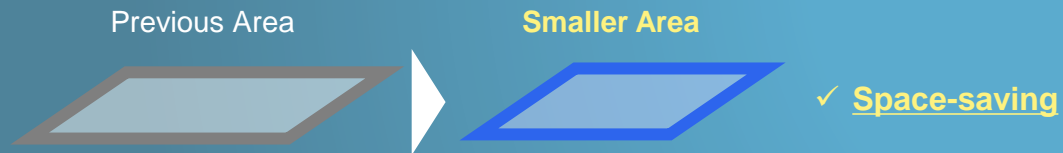

- 2 Improvement in Production Turnover Rate
Measures: Reduction in Production Lead Time through Production Process SX and Material Handling SX



Improvement in Turnover Rate through SX

“Smartification through IT / IoT / digitalization / data utilization / automation”

Production Process SX

Production Planning and Management



Document and Data Management



Engineering Skill Support



Material Handling SX

On-site Storage and Logistics System



Operations of a High-Performance Large-Scale Warehouse



Process Synchronization
Distribution Management



Note:

1. Production efficiency refers to production capacity per certain unit of equipment installation area. Production efficiency in Toyama factory in FY21/3 serves as benchmark

Tonami Factory Concept – Renewable Energy and BCP System

System that Utilizes Renewable Energy and Enables Business Continuity in Emergencies

Equipment Management SX 100% Renewable Energy System BCP Equipped System

100% Renewable Energy System



Realization of a facility that fully utilizes renewable energy sources and smart management

1. Solar power generation system that can operate the entire factory
2. Efficient operation of electricity through EMS implementation
3. Efficient operation of lighting and air conditioning using cameras and sensors
4. Smartification of remote monitoring and maintenance of equipment
5. Smartification of equipment failure diagnosis

Fully Equipped BCP System

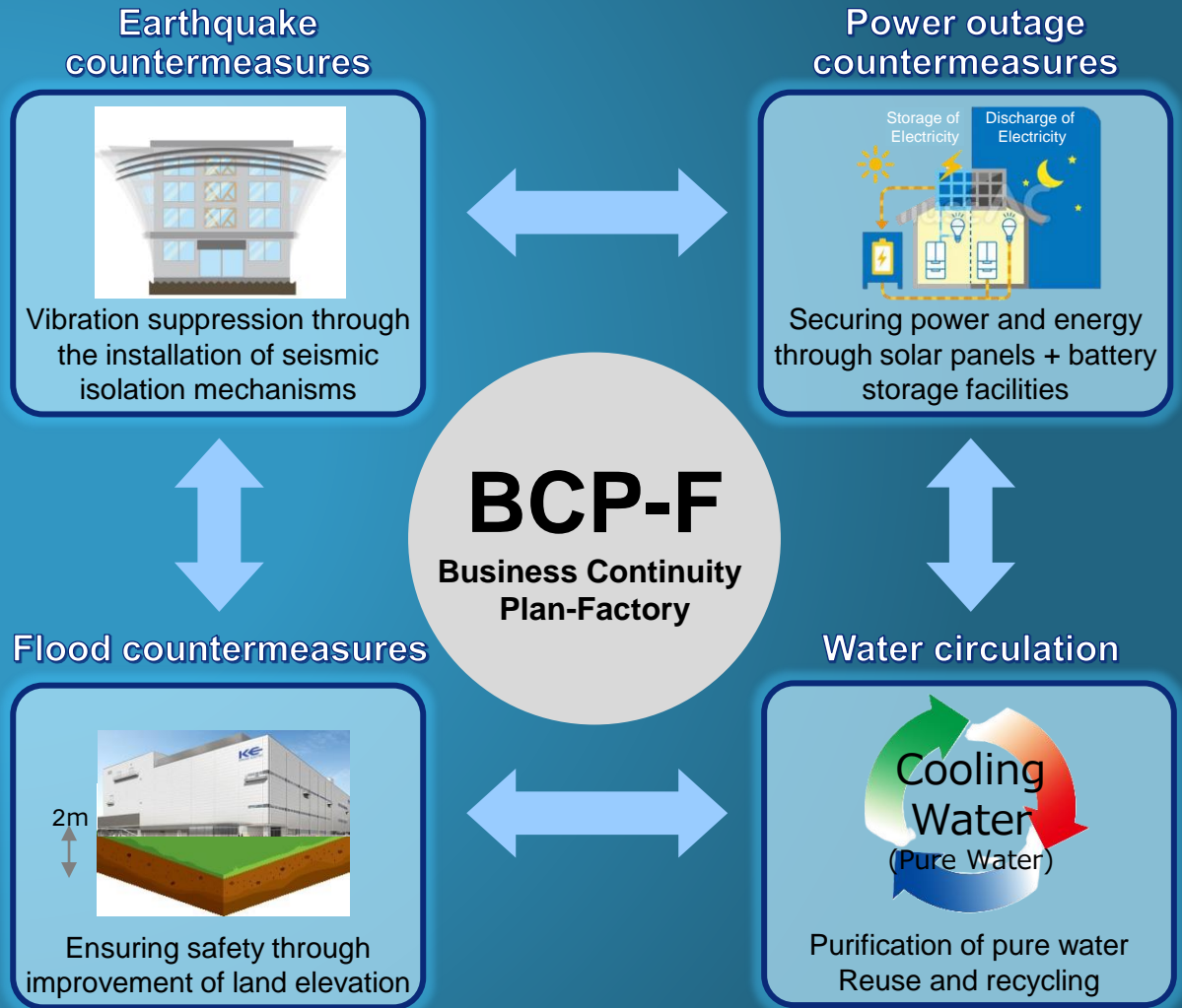

Strategy for Procurement Expansion

Multifaceted Expansion of Procurement Capabilities that Can Meet the WFE Market Trends Flexibly

Robust Procurement Framework

“Cube” Procurement Strategy

- Three-dimensional strategies for procurement items and businesses to meet the WFE market trend in each timeline

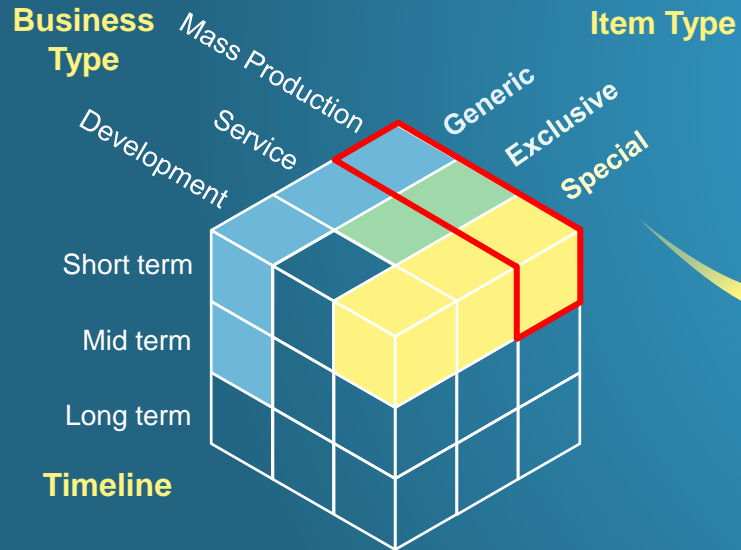

Portfolio Management

- Conducting portfolio analysis based on the technical and procurement difficulty of each item by business

(ex) Mass Production × Item Portfolio

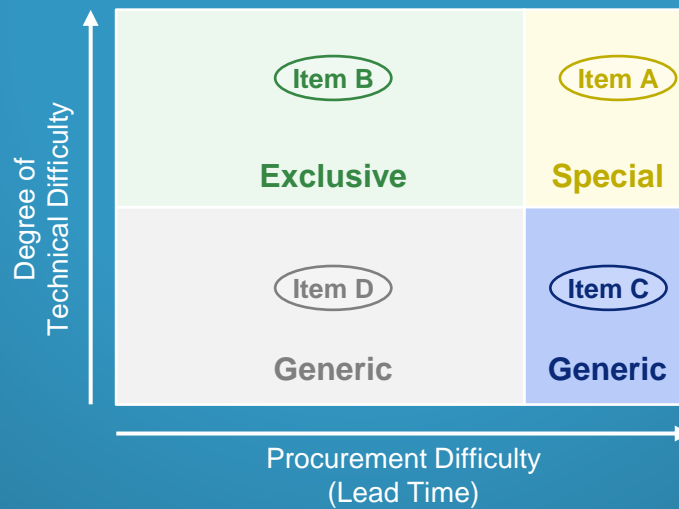

Partnering Measure

- Develop partnering strategies with suppliers to adapt to market changes

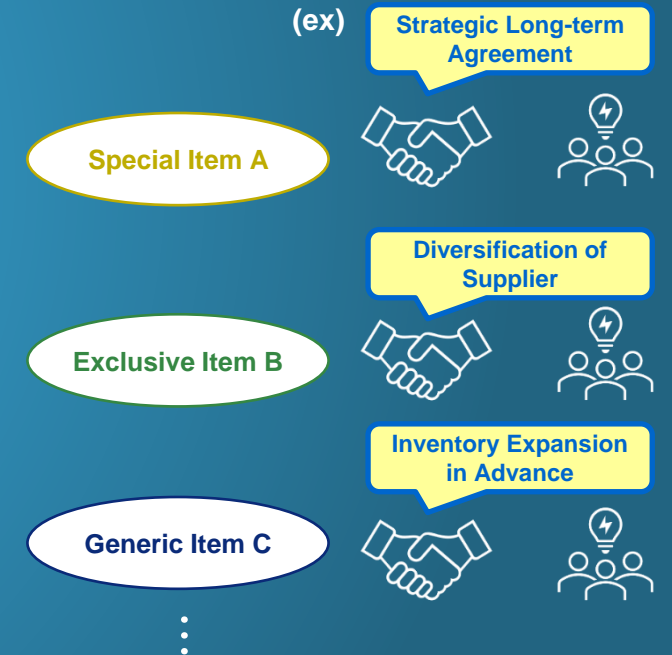

Achieve Expansion of Capacity, Stable Procurement and Cost Competitiveness, towards Building Robust Procurement System

Promotion of Sustainability in Supply Chain

Sharing our Philosophy and Compliance with Global Standards, Collaboration in Labor, Safety, Environment, Quality, Compliance, and BCP

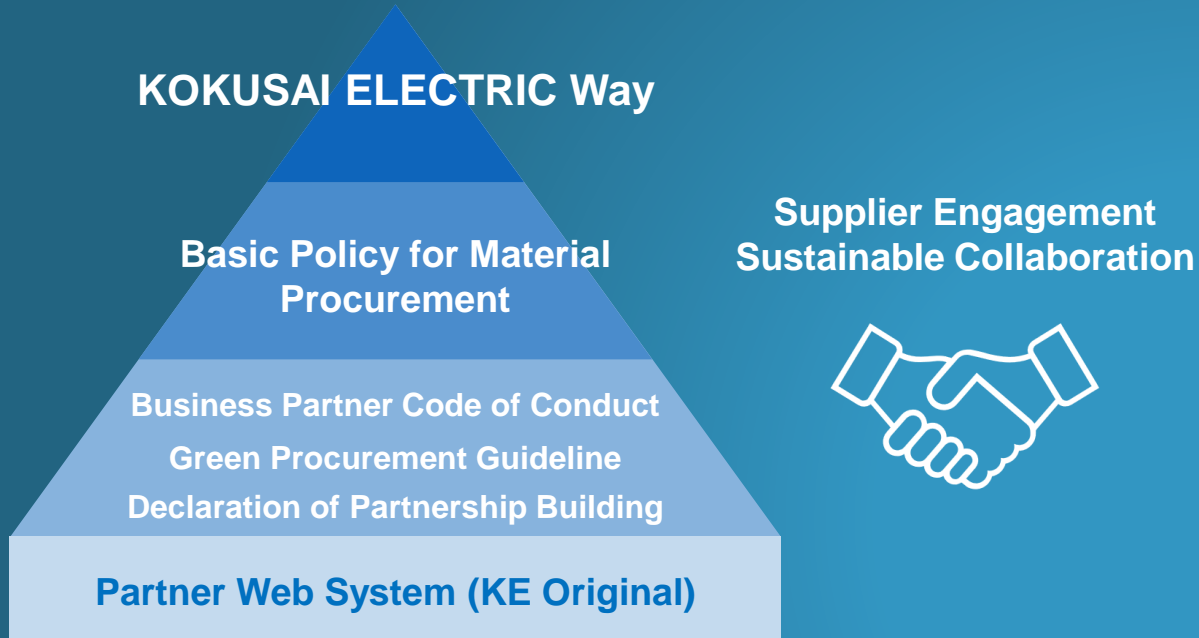

Basic Policy for Material Procurement

Established Basic Policy for Material Procurement and code of conduct to ensure compliance, achieving sustainable procurement practices in collaboration with our business partners

- Compliance with laws and regulations and social norms
- Prioritization of the environment
- Partnerships
- Open door
- Responsible minerals procurement
- Provision of information and maintaining of confidentiality

Strong Sustainable Partnership

Share timely updates on short- to medium-term business strategies, market trends, procurement, production, quality, and CSR information to establish collaborative "Win-Win" initiatives



Obtained Platinum Status VAP⁽¹⁾ Audits by RBA⁽²⁾



- ✓ Our Toyama Factory has achieved RBA Platinum Status (full score) in May 2024
- ✓ Recognized the compliance with RBA Code of Conduct for labor, health and safety, environmental, ethics, and management systems

Notes:

1. Validated Assessment Program

2. Responsible Business Alliance. Consisting mainly of US-based companies, it includes members from around the world. Since the alliance's formation, its main purpose has been to exercise social responsibility. It has formulated a Code of Conduct which includes suppliers and works to promote its widespread adoption.



Financial

Yoshitaka Kawakami, Senior VP
Finance & Accounting

Financial Model – Mid-Term Objectives⁽¹⁾

Targeting Higher Revenue and Margins, while generating ROE and ROIC that exceed WACC (approximately 9-10% in FY2024/3) through Excellent Capital Efficiency

WFE Assumption	FY2024/3	Mid-Term Objectives
	\$100 Bil (CY2023) ⁽²⁾	> \$120 Bil
Revenue	JPY 181 Bil	> JPY 330 Bil
Equipment (% Revenue)	65%	~ 75%
Service (% Revenue)	35%	> 25%
Adjusted OP Margin ⁽³⁾	20.9%	> 30%
R&D (% Revenue)	7.0%	> 6%
ROE (Reference)	15.7%	> 25%
ROIC (Reference)	10.1%	> 23%

Notes:

1. Regarding the Mid-Term Objectives, the landing prospects for the Mid-to-Long Term Objectives at the current point in time are described based on the current environment and progress

2. KE estimates

3. Adjusted Operating Profit is calculated as operating profit – other income + other expenses + purchase price allocation amortization + stand-alone related expenses + stock-based compensation (except for performance-linked stock compensation). Adjusted Operating Profit Margin is calculated as Adjusted Operating Profit / Revenue

4. The forward-looking statements included above are based on the current assumptions and beliefs of KE in light of the information currently available to it and involve known and unknown risks, uncertainties and other factors. Such risks, uncertainties and other factors may cause KE's actual results, performance, achievements or financial position to be materially different from any future results, performance, achievements or financial position expressed or implied by such forward-looking information

Disciplined Capital Deployment Plans

Capex, While Achieving Strong Returns to Shareholders

Stable Annual Capex Once One-time Growth Capex Completed

- Annual Capex of approx. JPY 4-6bn to keep expanding manufacturing and developing capacity to enable steady growth and efficiency, increase from a historical JPY 2-3bn level
- Completing one-time Capex for a new factory in Toyama, Japan and a demo room in S. Korea in FY25/3

Selective M&A in Adjacent Technologies

- Pursue M&A in adjacent areas with unique technologies, as well as key materials / components, but only selectively where strong synergy can be achieved

Strong Return to Shareholders

- 20-30% Dividend Pay-out, on par with international and domestic comps
- Once net cash⁽¹⁾ becomes positive, aim to use an amount equivalent to approx. 70% of Free Cash Flow after the redemption of interest-bearing debt⁽²⁾ towards flexible share repurchases and dividends
- The total payout ratio combining dividends and share buybacks is expected to be approximately 50% around the end of mid-term objectives

Notes:

1. Net cash = Cash and Cash Equivalents - interest-bearing debt

2. Defined as the sum of net cash from operating activities and net cash from (used in) investing activities, minus redemption of interest-bearing debt

3. The forward-looking statements included above are based on the current assumptions and beliefs of KE in light of the information currently available to it and involve known and unknown risks, uncertainties and other factors. Such risks, uncertainties and other factors may cause KE's actual results, performance, achievements or financial position to be materially different from any future results, performance, achievements or financial position expressed or implied by such forward-looking information

New Orders, Backlog and Revenues Trend

Strong Recovery of New Orders and Revenue Has Been Confirmed, with Backlog Turning into Sales

Half-yearly New Orders Trend

JPY Bil (aggregate value at end of half year)

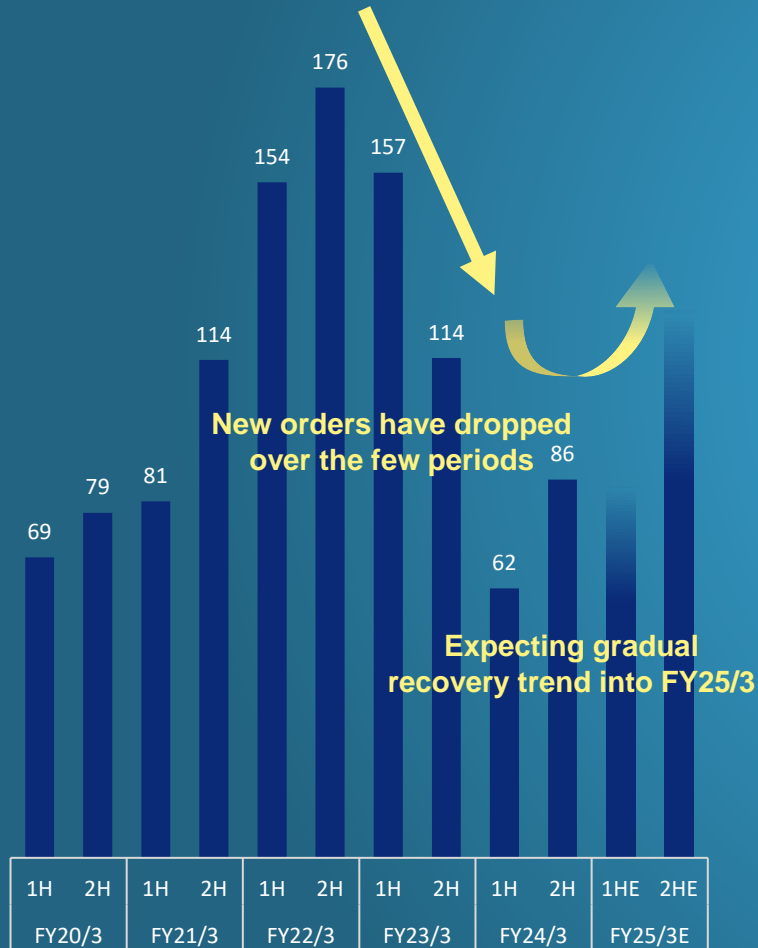

Half-yearly Backlog Trend

JPY Bil (aggregate value at end of half year)

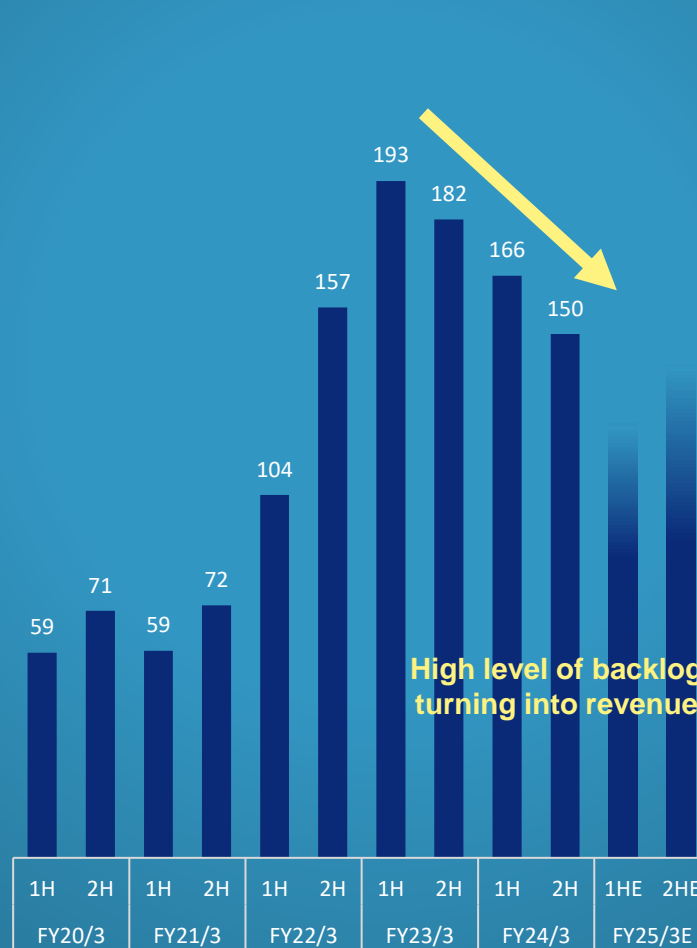

Half-yearly Revenue Trend

JPY Bil (value at end of half year)

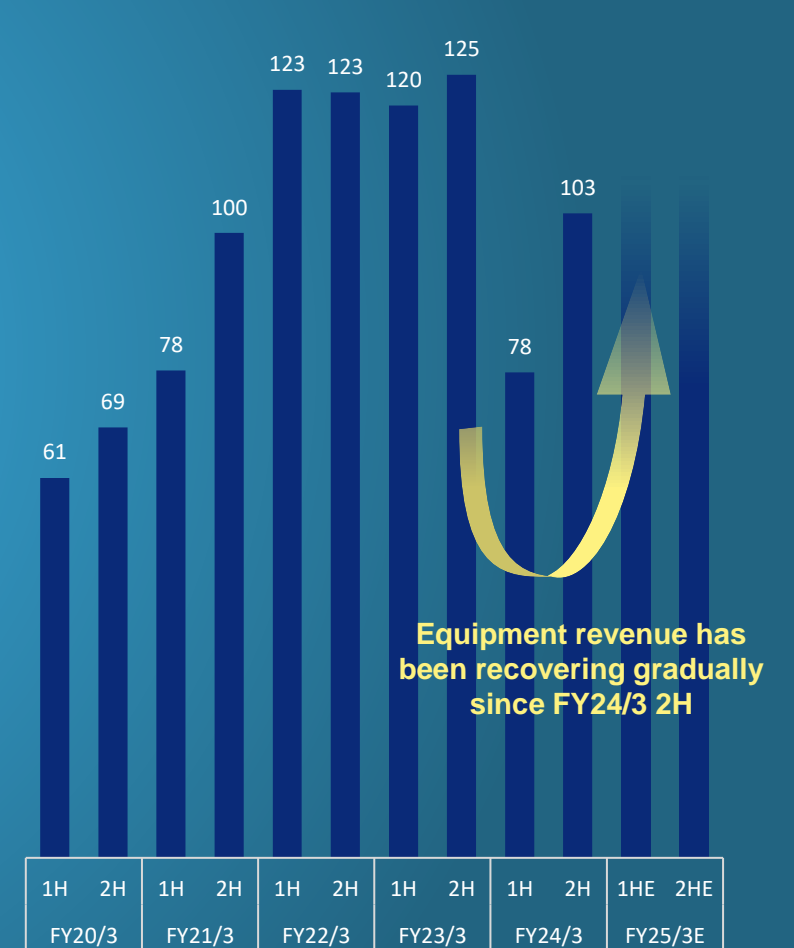

Note:

1. The forward-looking statements included above are based on the current assumptions and beliefs of KE in light of the information currently available to it and involve known and unknown risks, uncertainties and other factors. Such risks, uncertainties and other factors may cause KE's actual results, performance, achievements or financial position to be materially different from any future results, performance, achievements or financial position expressed or implied by such forward-looking information

Selected Consolidated Statements of Profit or Loss Data

(JPY Mil)	FY23/3	FY24/3
Revenues	245,721	180,838
% YoY	0.1%	(26.4)%
Cost of Sales	(144,916)	(105,873)
Gross Profit	100,805	74,965
% Margin	41.0%	41.5%
Selling, General and Administrative Expenses	(43,449)	(44,412)
Other Income	270	679
Other Expenses	(1,562)	(487)
Operating Profit	56,064	30,745
% Margin	22.8%	17.0%
Financial Income	909	339
Financial Expenses	(1,078)	(1,327)
Pre-tax Income	55,895	29,757
Income Tax Expenses	(15,590)	(7,383)
Net Income	40,305	22,374
% Margin	16.4%	12.4%

Reconciliation of Adjusted Operating Profit / Adjusted EBITDA

(JPY Mil)	FY23/3	FY24/3
Operating Profit	56,064	30,745
<i>% Margin</i>	22.8%	17.0%
Other Income ⁽¹⁾	(270)	(679)
Other Expenses ⁽¹⁾	1,562	487
PPA Amortization ⁽²⁾	6,369	6,369
Stand-alone Related Expenses ⁽³⁾	353	223
Stock Based Compensation	173	694
Total Adjustments	6,895	7,286
Adjusted Operating Profit	64,251	37,839
<i>% Margin</i>	26.1%	20.9%
Depreciation & Amortization ⁽⁴⁾	3,934	4,576
Adjusted EBITDA	68,185	42,415
<i>% Margin</i>	27.7%	23.5%

Notes:

1. Other income and other expenses from our statement of profit or loss, which are one-time and temporary items
2. Amortization of purchase price allocation asset which was recognized in connection with former Hitachi Kokusai Electric Inc.'s divestiture of its thin-film process solutions business to HKE Holdings Co., Ltd
3. Includes restructuring expenses
4. Excludes PPA Amortization

Reconciliation of Adjusted Net Income

(JPY Mil)	FY23/3	FY24/3
Net income	40,305	22,374
<i>% Margin</i>	16.4%	12.4%
Other Income ⁽¹⁾	(270)	(679)
Other Expenses ⁽¹⁾	1,562	487
PPA Amortization ⁽²⁾	6,369	6,369
Stand-alone Related Expenses ⁽³⁾	353	223
Stock Based Compensation	173	694
Total Adjustments	6,895	7,286
Tax Adjustment to Total Adjustments ⁽⁴⁾	(2,507)	(2,172)
Adjusted Net Income	45,985	27,296
<i>% Margin</i>	18.7%	15.1%

Notes:

1. Other income and other expenses from our statement of profit or loss, which are one-time and temporary items
2. Amortization of purchase price allocation asset which was recognized in connection with former Hitachi Kokusai Electric Inc.'s divestiture of its thin-film process solutions business to HKE Holdings Co., Ltd.
3. Includes restructuring expenses
4. Tax Adjustment calculated by multiplying tax rate to taxable items in adjustment items

Selected Consolidated Statements of Financial Position Data

(JPY Mil)	FY23/3	FY24/3		FY23/3	FY24/3
Assets			Liabilities and Equity		
Cash and Cash Equivalents	106,053	92,619	Loans Payable	6,000	7,500
Trade and Other Receivables	50,617	31,994	Lease Obligations	596	519
Inventories	67,197	87,682	Trade and Other Payables	41,790	36,667
Other Current Assets	2,053	2,619	Accrued Expenses	11,036	10,179
			Other Current Liabilities	42,031	32,678
Total Current Assets	225,920	214,914	Total Current Liabilities	101,453	87,543
Property, Plant and Equipment	18,775	35,382	Loans Payable	91,500	84,000
Right-of-use Assets	1,718	1,543	Lease Obligations	1,110	999
Goodwill	59,065	59,065	Retirement and Severance Benefits	3,032	3,153
Intangible Assets	62,968	56,995	Provisions	95	132
Other Financial Assets	1,564	1,652	Deferred Tax Liabilities	15,396	12,138
Deferred Tax Assets	943	1,403	Other Non-current Liabilities	72	80
Other Non-current Assets	2,586	4,479	Total Non-current Liabilities	111,205	100,502
			Total Liabilities	212,658	188,045
			Common Stock and Capital Surplus	38,346	38,880
			Retained Earnings	119,783	142,448
			Others	2,752	6,060
Total Non-current Assets	147,619	160,519	Total Equity	160,881	187,388
Total Assets	373,539	375,433	Total Liabilities and Equity	373,539	375,433

KOKUSAI ELECTRIC